

Nomura Research Institute, Ltd.

Otemachi Financial City Grand Cube,
1-9-2 Otemachi, Chiyoda-ku,
Tokyo 100-0004, Japan
Tel. +81(3)5533-2111
<https://www.nri.com/en>

NRI

未来創発
Dream up the future.

Nomura Research Institute

Integrated Report 2021

Year ended March 31, 2021

Our Founding Spirit Continues to Be Passed Down

“To promote industry and be of service to society through research studies” and “to take the varied expertise acquired through advanced system development and put it to use for management rationalization and other benefits of more companies” are, respectively, the founding spirit of the former Nomura Research Institute, Ltd., and of Nomura Computer Systems Co., Ltd.

We have carried on the founding spirit of both companies even until today as we have created new social value and resolved the challenges faced by society and by our clients, by providing consulting and IT solutions.

1965 Research consulting

(Former) Nomura Research Institute established

Japan's First Full-fledged Private Sector Think Tank

The origin of NRI's consulting business goes back to 1965 when Nomura Securities Co., Ltd., expanded the functions of its Research Division and established the former Nomura Research Institute, Ltd. The objective was to make a dramatic leap to develop into a high-quality research and investigation institution.

The founding prospectus, “Nomura Research Institute—its Concept and Policies,” describes the following as the aims of establishing the Institute: “To be a new type of research institute that had never existed in Japan before,” and “To promote industry and be of service to society

through research studies.” This has been passed down to today in NRI's DNA, which makes it an organization with the primary goal of creating new social value and engaging in the resolution of social issues through its main business activities.



The founding prospectus of former Nomura Research Institute (Produced by Nomura Securities in 1962)

system development as Nomura Securities and put it to use for management rationalization and other benefits of more companies. The philosophy indicates an attitude to be of service to society as well as create new value.

* Company name changed to Nomura Computer Systems Co., Ltd., in 1972.

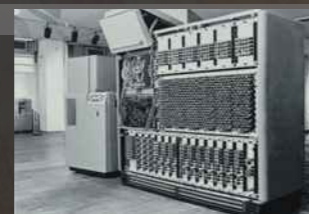

The commercial computer (UNIVAC-120) adopted by Nomura Securities

1966 IT solutions

Nomura Computer Systems established

Japan's First Commercial Use of Computers

The origin of NRI's IT solutions business is the Electronic Data Processing Division of Nomura Securities Co., Ltd., that was established in 1953. In 1955, the division adopted the use of a commercial computer (UNIVAC-120) that had just been developed in the United States, making headlines as the first instance in Japan of the commercial use of a computer. This is the result of the desire and passion to create new systems previously unseen in the world.

In 1966, the Electronic Data Processing Division spun off from Nomura Securities to become the Nomura Computing Center Co., Ltd.* The philosophy of its establishment was to take the varied expertise acquired through advanced

1988



Launch of new NRI



2001

Listed on the First Section of the Tokyo Stock Exchange



2015-

Vision2022 long-term management vision and “Share the Next Values!” vision statement released

“

“When forecasting the advanced information society to come, there can be no think tank without a systems function, and there can be no systems company without a think tank function”

(From the press conference following the signing ceremony for the new NRI)

”

The History and Mission of NRI

In a move that foresaw an ideal information services company, the former Nomura Research Institute, Ltd., and Nomura Computer Systems Co., Ltd., merged to become the new Nomura Research Institute, Ltd., (NRI) in 1988. The new NRI succeeded the spirit of the two companies from the time of their founding. It would do more than simply provide research, consulting, and IT services; the company would create new social value, making its mission the resolution of challenges faced by society and clients.

Sustained Growth Over Many Years

Since its founding, NRI has continued to anticipate changes and grow, even amid a variety of economic fluctuation and economic crises. In every era, we have worked to achieve sustained growth in both consulting and IT solutions.



Creating Future Society Together

NRI believes that true value is not in merely predicting the future but is in creating the future ourselves.

Under the corporate philosophy of “Dream up the future” that has been passed down to us and builds on the founding spirit, we will continue to engage in the resolution of social issues and take on the challenge of building a sustainable future society with our clients.

Corporate Philosophy

未来創発 Dream up the future.

The NRI Group's corporate philosophy consists of four pillars: mission, business domain, management goals, and action guidelines.

Mission	Business domain	Management goals	Action guidelines
<p>To society: Discerning new social paradigms and assuming the role of implementing such paradigms</p> <p>To clients: Building clients' trust and prospering together with clients</p>	Company creating future society	Pursuing the maximization of corporate value through “Navigation × Solution”	Continuing never-ending challenges with pride of true professionals

The NRI Group Business

The NRI Group business is divided into four business segments: Consulting, Financial IT Solutions, Industrial IT Solutions, and IT Platform Services. While maintaining an industry-top-level competitive edge in its respective domain, each business segment flexibly forms teams with other segments as needed. The NRI Group's strength is its possession of both consulting and IT solutions functions. This makes it possible to swiftly and consistently provide on-target solutions that solve the priority issues faced by clients and society.

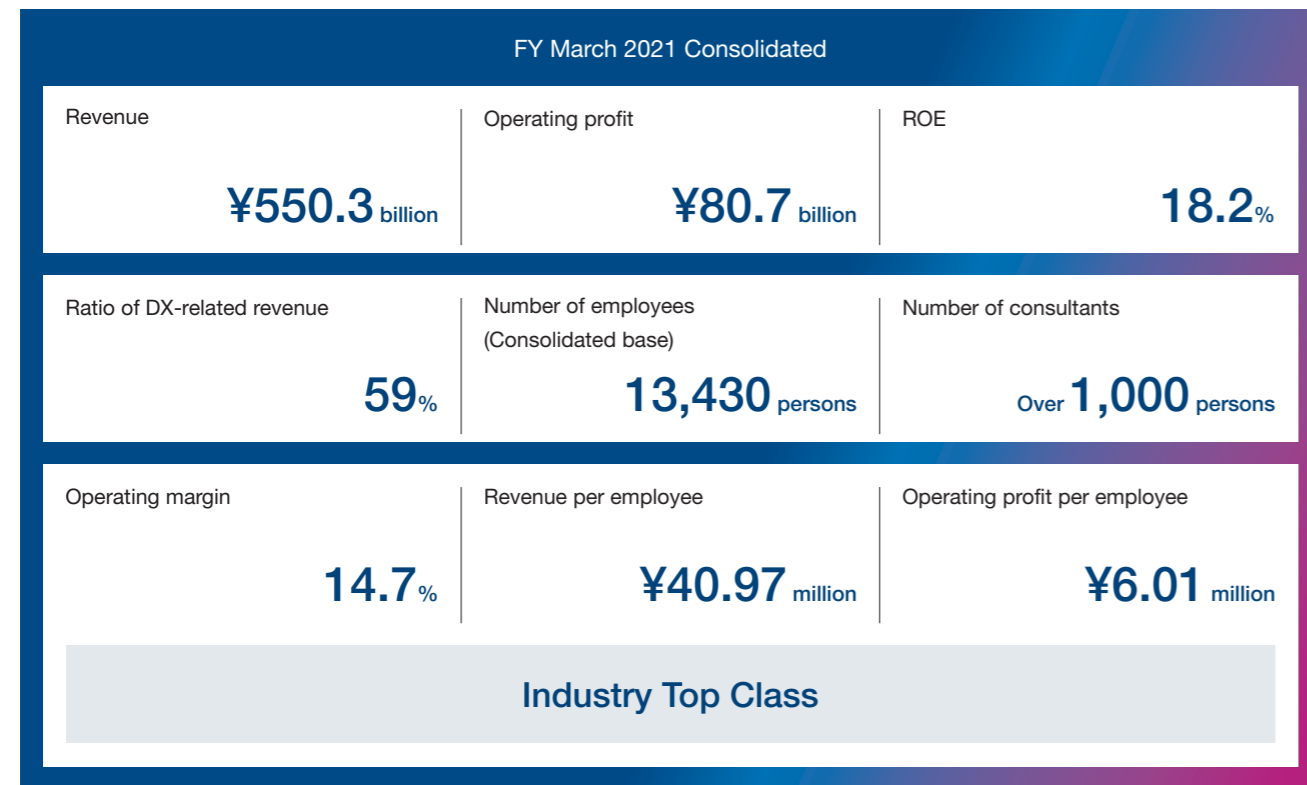

Revenue / Operating Profit / Operating Margin (billions of yen)



NRI's Four Business Segments [P.92-101](#)

Consulting

This segment provides management consulting, operational consulting, and system consulting for enterprises and government agencies. This segment is also engaged in research, future projections, and recommendations related to society, economics, business, and technology, etc.

Financial IT Solutions

This segment provides system consulting, system development and system management solutions, shared online services, and BPO services for financial institutions mainly in the securities, insurance, banking, asset management, and other financial sectors.

Industrial IT Solutions

This segment provides system consulting, system development and system management solutions, and shared online services mainly for the distribution, manufacturing, service, and public sectors.

IT Platform Services

This segment provides data center operations and construction of IT platforms and networks are provided to the Financial IT and Industrial IT Solutions segments. This segment also provides IT platform solutions and information security services to external clients. Furthermore, NRI conducts research related to advanced information technology, etc.

External Revenue by Segment

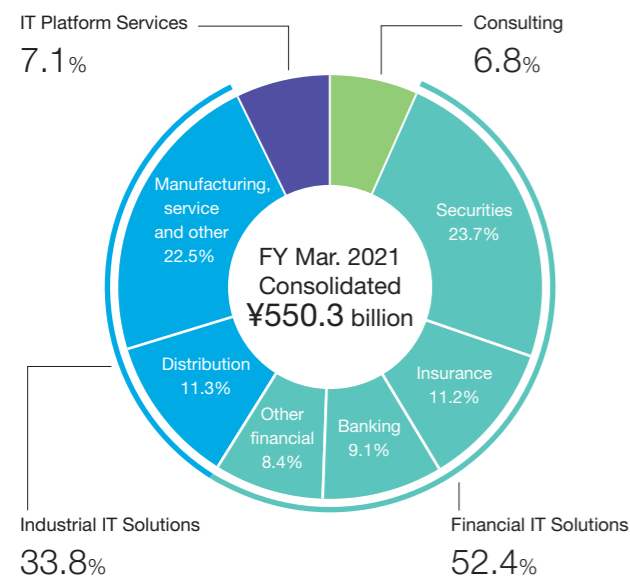

External Revenue by Service

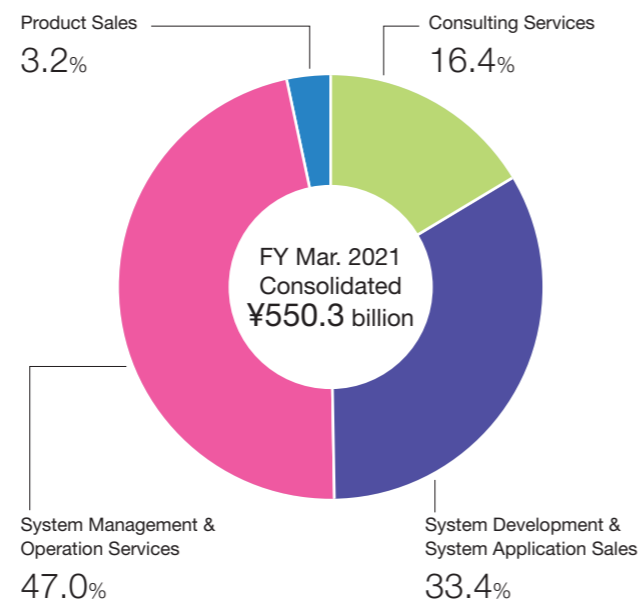

Note: Ratios are for consolidated sales in FY March 2021.

COVER STORY	
6	Business Overview
6	The NRI Group Business
8	Contents / Editorial Policy
10	Top Message
18	NRI's Value Co-Creation
18	A Path of Unchanging Value Co-Creation
20	Process of Value Co-Creation
22	Business Model
23	Competitive Advantages
26	Utilization of Capital
28	NRI's Capital and the Creation of Value through its Utilization
30	Opportunities and Risks due to Changes in the External Environment
32	Financial Highlights
34	Non-Financial Highlights
36	Growth Strategy
36	Looking Back on Past Medium-Term Management Plans
38	Vision2022 and Medium-Term Management Plan Overview and Progress Status
45	Embracing the Challenge of Solving Social Issues
46	Financial Strategy Message from the Head of Finance
48	Mechanisms for Supporting Value Creation
48	NRI Sustainability Management Policy
50	NRI's 3 Social Values (Solving Social Issues through Value Co-Creation)
53	Materiality for Sustainable Growth
54	Special Report: Awareness Building Activities for Value Co-Creation
56	Message from the Head of Corporate Headquarters
	58 NRI's Human Resources Strategy
	60 Development of DX Human Resources
	62 Promoting Diversity and Inclusion, and Respect for Human Rights
	64 Work-Style Reform Issues and Health and Productivity Management
	65 Cooperation with Stakeholder
	67 Information Disclosure and Communication
	68 NRI's Quality Management
	72 Environmental Impact Reduction Activities for Preserving the Global Environment
	74 Initiatives for the TCFD Final Report
	80 NRI's Corporate Governance
	82 System of the Board of Directors and the Audit & Supervisory Board
	84 Compensation for Members of the Board and Audit & Supervisory Board Members
	87 Message from the Outside Member of the Board
	88 Internal Controls, Corporate Ethics, and Compliance
	90 NRI Executives
92	Business Segments
92	NRI's Four Business Segments
94	Consulting Segment
96	Financial IT Solutions Segment
98	Industrial IT Solutions Segment
100	IT Platform Services Segment
102	Corporate Information / Data
102	10-Year Summary Consolidated Financial Statements
104	Consolidated Financial Data
106	ESG Data
108	NRI Group Network
109	Corporate Data / Share Information

Editorial Policy for the Integrated Report 2021

Since FY March 2014, NRI has published integrated reports that provide explanations while associating important financial and non-financial information. These reports aim to give an overall picture of NRI in a concise and clear manner.

The Integrated Report 2021 has improved its content using feedback from stakeholders as reference. In particular, regarding NRI's value co-creation, we have introduced the contents of our sustainability management together with details on specific efforts. Further, we have worked to provide ample descriptions of our past efforts, including the history of our value co-creation and reflections on growth strategy.

As for details and other related information that cannot be included due to space, we have included the source of the relevant information (e.g., websites and the Annual Securities Report) within the pages of this Integrated Report for your use.

NRI works toward the medium- to long-term enhancement of its corporate value. We strive for even deeper communication with stakeholders to enable the determination of its value.

Guidelines Referenced for the Disclosure of Information



Categorization for NRI's Disclosure Information



Cautionary Note on Forward-Looking Statements:

- This Integrated Report is prepared for the purpose of providing information on our performance in FY March 31, 2021 and our strategy for the coming years, not for the purpose of attracting investment in stocks issued by Nomura Research Institute, Ltd. (NRI). In addition, this report contains absolutely no guarantees or pledges.
- The opinions and outlook contained herein reflect the views of management at the time of preparation. We do not offer any guarantees or pledges as to the accuracy or completeness of such information, which, moreover, is subject to alteration without advance notice.
- NRI holds all rights to each and every part of the integrated report, which may not be reproduced, transmitted, or otherwise duplicated by any means, whether electronic or mechanical, whatever the purpose, without our express permission.
- For the purpose of convenience within this report "NRI" is used to refer to the Company and in certain places the entire NRI Group.



NRI will continue to practice its corporate philosophy, “Dream up the future,” and co-create social value that is distinctive of the Group.

July 2021

Shingo Konomoto

Chairman and President & CEO,
Representative Director, Member of the Board

Changes that were expected to require 10 years to achieve are taking place at once.

The lives of people around the world continue to be at the mercy of the COVID-19 pandemic. I would like to express my heartfelt appreciation to health care professionals, committed to working at the forefront of medical care, and other essential workers who have been providing us with the essential services that make it possible for us to maintain our lives.

The COVID-19 pandemic has changed our lives drastically. The spread of telecommuting significantly increased people’s disposable hours, creating free time. Furthermore, the increase in matters going online (becoming non-face-to-face), which resulted from dramatic behavioral changes, has also brought about a release from spatial restraints. Such changes in the behaviors of consumers and companies are creating bipolarization. In addition to an expansion in stay-at-home demand, such as for online entertainment and e-commerce, new businesses are appearing, one after another, in the direct-to-consumer field. While, on the one hand, there are some companies that are benefiting in such ways, there are also those that find themselves in an extremely difficult business environment.

I believe that an affluent society in which we can be strong and resilient toward risks and live in safety and security can be achieved through the power of digitalization.

Digital transformation (DX) has become indispensable for Japanese companies to promote global competitiveness. However, as has been pointed out in the Ministry of Economy, Trade and Industry’s “DX Report,” outdated, legacy systems and software are factors obstructing the progression of DX in Japan. The modernization of such legacy systems is required for non-face-to-face sales systems, the digitalization of contact with clients, and other changes to a company’s front office. Such work requires the resolve to destroy existing structures as well as bold investment decisions. Bottom-up design was the mainstream approach of past systems that were constructed with its focus on streamlining work processes. Meanwhile, some companies that are leading DX efforts are taking the top-down design approach in promoting their transformation. In leading the way, members of top management are executing daring investments. Up to now, such moves were limited to a small number of companies taking the lead. However, many companies, which have realized the necessity of implementing transformation that utilizes digital means, are embarking on DX through top-down designs.

The COVID-19 pandemic has heightened the momentum for reform. I have the sense that the changes that we expected would require five to ten years to achieve are now taking place at once.

The Medium-Term Management Plan was steadily able to pass its halfway point.

Vision2022 (V2022) is our long-term management vision that spans the period from FY March 2016 to FY March 2023. In it, we have set as our targets an operating profit of ¥100 billion, operating margin of 14% or more, revenue from global business of ¥100 billion, and an ROE of 14%. We established our direction for the four years that constitute the latter half of V2022 in the Medium-Term Management Plan (2019–2022). The outlook for FY March 2021, which was the second year of this plan, initially looked grim. However, ultimately, we ended the fiscal year with increases in both revenues and profits. Our financial performance exceeded the initial plan.

FY March 2021 was positively impacted by the momentum of the aforementioned business model reform. Contributing to our performance was growth in the DX projects of our large clients as well as in clients' adoption of THE STAR, a shared online service for brokerage firms. The DX Strategy, which is the growth strategy established under the Medium-Term Management Plan, made steady progress.

NRI will promote its business with a focus on challenging, high added-value areas and technology that is of benefit to society. These are what lead to the operating margin that is at an overwhelming level compared with our competitors in Japan, consolidated operating profit per employee, and an EBITDA margin that is higher than our overseas competitors. The revenue ratio of our non-financial sector is also growing year after year. Our business portfolio is one in which recurring business, which stably generates income, accounts for more than 60% of revenue. FY March 2021 was a year in which we were able to show the full merit of such a business structure that is highly resilient toward economic fluctuations. Having smoothly passed the halfway point of the Medium-Term Management Plan, NRI has

taken a strong step into the third year of the Plan.

We will firmly capture the demand for DX where we expect to see continuing expansion.

Our forecast is that we will again see growth in both revenues and profits in FY March 2022, the third year of the Medium-Term Management Plan.

The DX investment of companies that have been taking the top-down design approach in their promotion of DX is accelerating under even stronger leadership. We intend to stay side-by-side with such clients through the intensive injection of resources that will meet the speed of transformation.

For our clients who are earnestly undertaking the task of breaking away from legacy systems and achieving DX, we will also offer our assistance, starting with upstream consulting services. We will work with them to achieve DX through the provision of services for business overall, inclusive of information technology.

We believe that the expansion of this demand that surfaced at once will continue. We expect that demand will arise in waves going forward. Furthermore, in contrast to hardware and conventional core systems, which have the most value at the moment of their completion, software that supports "X as a service," e-commerce, and other business models, is repeatedly updated after the service is launched, and there is a need to enhance its value through the use of technology, such as machine learning and analytics that utilize the accumulated data. Conventionally, the demand structure formed a temporary peak. However, due to the aforementioned characteristics, it is beginning to change into one that continuously accumulates, for example, and is more enduring. NRI will work to steadily amplify its resources. With assuring quality as the major premise, we will undertake standardization and modularization to the extent possible. By doing so, we will improve productivity as well as contribute to the sophistication of the services provided by clients.



Thirty-four years after the merger, we now have increasing opportunities to further exhibit the strength of Con-Solution in which consulting and IT solutions come together and support clients in their promotion of DX.

We will demonstrate the full worth of Con-Solution and provide high added value.

As DX gained momentum through the implementation of top-down design, we became highly aware of the importance of the relationship of trust with those in management. By understanding management's determination, providing required resources at a similar kind of speed as clients, and earning their trust, we strive to be chosen continuously by our clients as a strategic partner. Con-Solution is a business model that is unique to NRI. It becomes a forceful factor for differentiating us as we build such relationships of trust with clients.

To achieve DX, a strategic partner that is capable of transforming work processes, creating business models, and swiftly implementing the necessary IT for their realization, while at the same time, discussing things together is indispensable. NRI is capable of comprehensively providing such functions. NRI made a new start through the 1988 merger

of the former Nomura Research Institute, Ltd., (Japan's first private sector think tank) and Nomura Computer Systems Co., Ltd., (the first company in Japan to make use of a commercial computer in business). In 2016, a year following the launch of V2022, we strengthened the continuous integrated operation of our consulting services and IT solutions services, such as by establishing NRI Digital, Ltd. In Con-Solution, the business model that was honed through such processes, consultants and systems engineers collaborate to work side-by-side with clients, from the initial planning stage of DX strategies. Even after systems become operational and clients' businesses are launched, we contribute to the transformation of our clients' business models by enhancing value, such as through data analysis. While moves to strengthen consulting services have become active in the industry, we believe that we have a decisive advantage of having accumulated over many years, ahead of others, the capability to develop hypotheses based on a deep understanding related to the operations,

businesses, and strategies of our clients. NRI will continue to pursue a further evolution by honing such advantages.

We will launch a challenge for new transformation that is appropriate for Digital Transformation 3.0.

NRI has been promoting DX strategies that primarily contribute to the transformation of clients and the industry. DX 1.0 primarily contributes to the renovation of work processes and infrastructures. Meanwhile, DX 2.0 is a strategy that contributes to the creation of new business models and ecosystems via digital technologies. The resolution of social issues has been required even more strongly in recent years. We believe that digital technologies will also be playing an even greater role in the resolution of social issues. That is why NRI intends to undertake DX 3.0 that co-creates new themes with social issues as their starting

point. Although the policy is to explore various possibilities, one of the leading themes is carbon neutrality.

Triggered by the move toward carbon neutrality, various matters will be made into services and shared over platforms, while reducing the amounts of resources used and greenhouse gas emissions. We expect that such structural changes through which our world will be optimized into an affluent society will progress rapidly over the next 10 years. The new economic systems, represented by this kind of sharing economy, is none other than the very nature of the digital capitalism that we have been proposing through the NRI Dream Up the Future Forum, books, and other means as part of making social recommendations and system proposals.

Industrial capitalism was premised on population growth, and economic activities were centered around production and consumption. As populations decline and

digitalization progresses rapidly in leading industrialized countries, a shift is occurring to a new economic system – digital capitalism in which data becomes the source of added value. In it, the main actors have transitioned from industrial capitalists and laborers to digital platforms and users. The definition of value has also moved from possession and use to utility. It is a vision of a society in which “X as a service” on digital platforms cuts across various industries and expands the sharing of non-operating assets. To achieve this, there is a need for the public and private sectors to work as one and accelerate the evolution of the digital social capital. This includes the promotion of a digital government, preparation of a shared digital infrastructure, the redesigning of the social and industrial structure toward a rich and secure life, and the improvement of productivity.

With an eye on the progress of digital capitalism, NRI is attempting the evolution of business models that go beyond conventional frameworks, including a platform-based business in which various players provide X as a service. Depending on circumstances, there may be a chance that NRI itself provides a platform. Co-creation with stakeholders becomes indispensable in the development of such mechanisms and their implementation in society. We will contribute to the achievement of a sustainable future society by co-creating with clients and partners social value that is distinctive of NRI. The process on the way to this is consistent with the passion that is behind our corporate philosophy.

We will contribute to the achievement of a sustainable future society through business activities.

The founding spirit is incorporated in the “Dream up the future” corporate philosophy, which states our mission: “Discern new social paradigms and implement them” and “Build client trust and establish relationships for mutual growth.” The corporate philosophy contains our thinking that the continued enhancement of NRI’s corporate value can be found only through the resolution of social issues through innovation. NRI’s corporate value consists of two facets. That is, economic

value in the form of the achievement of financial targets, and social value, or contributing to the achievement of a sustainable future society through business activities.

The Medium-Term Management Plan specifies Creating Shared Value (CSV) as the initiative for solving social issues through value co-creation. CSV links solving social issues to the generation of business opportunities and is being promoted as NRI Sustainability Management. “Co-create a thriving future society by driving new value,” “Co-create an ideal society by effectively utilizing its resources,” and “Co-create a safe and secure society by advancing its infrastructure” are defined therein as the NRI’s 3 Social Values. Toward “Co-create a thriving future society by driving new value,” we are energetically making recommendations, such as those related to various social issues including unemployment among women and a post-corona vision of the future. In regard to “Co-create an ideal society,” we are contributing to our clients’ reduction of CO₂ emissions through a shared business platform service for financial institutions. Furthermore, toward the reduction of environmental impact for preserving the global environment, NRI’s data centers will proactively adopt the use of renewable energy. As for “Co-creation of a safe and secure society,” we will undertake various efforts for promoting the use of My Number Cards for progress toward a digital society. We will establish non-financial KPIs linked to our growth strategy for each of these 3 Social Values and work on them robustly every quarter while implementing the PDCA cycle. We are spreading understanding of the corporate philosophy to each employee so as to continuously promote such value co-creation.

I see spreading value co-creation as an important mission of mine.

For NRI to continue to be an “indispensable existence” for the world, we must give our attention to the challenges being faced by clients and society as a whole. We must give serious consideration to ways for overcoming these challenges. Working to solve the many social issues that are present on a global scale is the duty of all companies. Solving social

NRI’s corporate value consists of two facets. That is, economic value in the form of the achievement of financial targets, and social value, or contributing to the achievement of a sustainable future society through business activities.



issues through the company's business is not a special act for NRI, which upholds "Dream up the future" as its corporate philosophy. Rather, it is something that we implement as part of our everyday operations. As solving issues becomes increasingly complex, NRI's capability to consistently provide services, from consulting to IT, should enable us to exhibit great strengths. What can we do for the achievement of a sustainable future society? How should we further hone and exhibit our strengths? These are questions that each one of us must ask ourselves.

Led by the Social Value Creation Promotion Committee, which promotes the internal spread of the corporate philosophy, NRI has been working since 2019 to nurture value co-creation leaders, who will spread value co-creation to all employees and lead the next generation, as well as provide assistance in cross-organizational efforts. With the awareness that these are my important responsibilities, I carry out dialogue with such value co-creation leaders and work to foster empathy.

We are steadily promoting the recruitment of human resources and engaging in their development so as to capture current demand with certainty and continuously achieve value co-creation thereafter.

Under the Human Resources Strategy contained in the growth strategy of the Medium-Term Management Plan, we are aiming to increase the number of employees by around 1,000 over four years. We have been steadily hiring highly talented human resources every year toward the achievement of this plan.

Furthermore, human resources development is also progressing steadily. We have prepared a training program consisting of roughly 100 courses that will enable acquisition of the comprehensive technologies and skills required for DX. In FY March 2021, one and a half times more employees than the previous year took the courses online.

The global strategy is also moving ahead steadily toward the continuous improvement of corporate value.

The structure of our current business portfolio is one focused around the domestic Japanese market. We see expanding this globally as being an important management issue. That is why the Global Strategy was included as part of the growth strategy in the Medium-Term Management Plan and is being promoted with a long-term view. NRI places priority in high added-value areas. Because of this, industrialized countries that have reached a certain level of maturity become candidates for the expansion of our business. Among them, we are carrying out business development with a focus on Australia, due to its high rates of population and IT market growth. Because it will be centered for the time being around external growth through M&A, Australia's rational valuation will also become a favorable condition.

ASG, which became part of the NRI Group in 2016, has grown into a company that provides consistent services, from consulting to IT solutions and management. Furthermore, in May 2021, NRI made two Australian companies into subsidiaries. One is AUSIEX, which provides back-office services, such as securities transaction and portfolio management, in the Australian wealth management market where long-term growth is expected. The other is Planit, which is the largest IT testing company in the Oceania region. Both new subsidiaries share NRI's sense of values in terms of the provision of high added-value services.

Through this, we have taken a large step forward toward building a business model in Australia that is similar to the one in Japan. That is, the provision of IT consulting, development, management, BPO, and security for the finance, public, and industrial sectors, under NRI Australia, which oversees the Australia region. Our policy is to aim for business expansion through further M&A, in addition to organic

With each of us demonstrating possessed strengths, we would like to continue to be an "indispensable existence for the world" toward the achievement of a sustainable future society.



growth, while improving and expanding services.

NRI will fulfill its mission and contribute to the progression toward digital capitalism.

It is impossible to correctly forecast what technology and society will be like in 10 years. Even so, in that future, we expect that the integration of business and IT will progress even further. And, we believe that what we need to promote with certainty is to contribute to the

development of digital capitalism that will achieve a rich life for all people. With our mission, "Discern new social paradigms and implement them" in our hearts, NRI will work to continue to be an indispensable existence for society.

Shingo Konomoto

Chairman and President & CEO,
Representative Director, Member of the Board

A Path of Unchanging Value Co-Creation

We were established in 1988 through the merger of the former Nomura Research Institute, Ltd., Japan's first private sector think tank, and Nomura Computer Systems Co., Ltd., a leader of Japan's IT industry. NRI succeeded the spirit of the two companies from the time of their founding. It would do more than provide research, consulting, and IT services.

The Company would continue to create new social value, making its mission the resolution of challenges faced by society and clients.

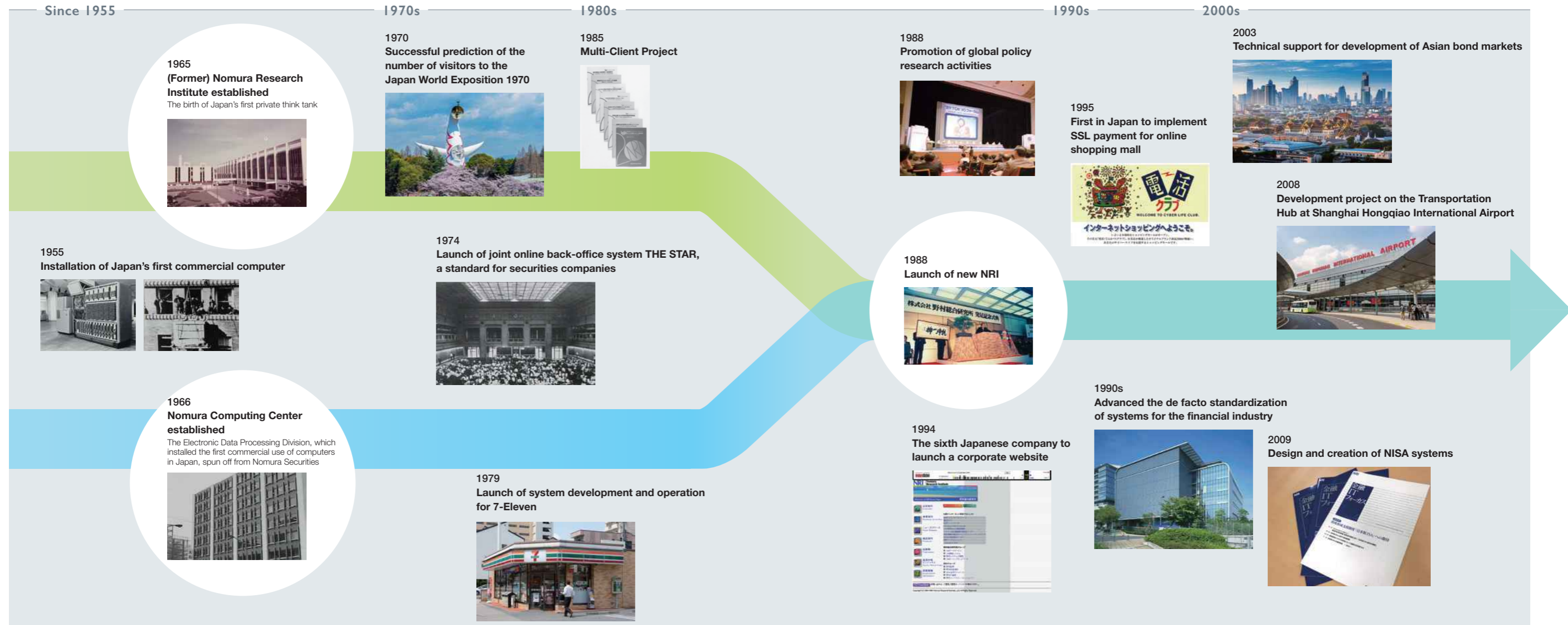

Services Created in Response to Societal Demand

Consulting

- 1970** Forecasted the number of visitors to the Japan World Exposition held in Osaka (a pioneer in research and consulting business in Japan)
- 1984** System Clinic Service launched (a pioneer in system consulting business in Japan)
- 1988** Started recommendation activities of the world's five big think tanks, including NRI (thereafter annually through 1995)
- 1989** Organized Pension Management Study Group (affected Japan 401K scheme later)
- 1994** Became the sixth company in Japan to launch a corporate website
- 1995** Center for Cyber Communities Initiative established with Keio University
Cyber Life Club cybermall launched (a pioneer in online shopping business in Japan)
- 1997** Conducted the first Survey of 10,000 Consumers (thereafter conducted every three years)
- 2000** Advocated the concept of Ubiquitous Networking (a new information technology paradigm)
- 2003** Started sending CIO aides to government organizations, including the Ministry of Health, Labour and Welfare, the Ministry of Agriculture, Forestry and Fisheries etc.
- 2007** Established Tsinghua-NRI Chinese Research Center
Insight Signal, advertising effectiveness measurement service launched
- 2011** Recommendation activities and others for Great East Japan Earthquake recovery efforts
- 2012** Provided comprehensive support, from designing the service to the system architecture, for Shiseido's integrated online beauty service "watashi+"
- 2014** Assisted the rollout of "NISA" system, from design to system construction
- 2020** Proposals regarding Coronavirus Infection (COVID-19) measures

IT Solutions

- 1970** Launched Nomura Securities' "Integrated Online System"
- 1974** THE STAR, a shared online service for retail brokerage firms, launched
- 1979** Launched a new ordering system for SEVEN-ELEVEN JAPAN CO., LTD.
- 1987** I-STAR, a shared online system for wholesale brokerage firms, launched
- 1987** Famicom Trade System in Nomura Securities launched (a pioneer in contemporary home trading services)
- 1988** International VAN service between Japan and United States launched
- 1993** T-STAR, a shared online system for asset management firms, launched
- 1997** BESTWAY, an over-the-counter sales system for mutual funds launched
e-Cash experiment with Japanese commercial banks (Japan's first electronic money trial)
- 1999** Online trading system for an online brokerage firm launched
- 2004** e-JIBAI, a compulsory automobile liability insurance system, launched
- 2012** Value Direct (for online banking) launched
- 2016** TRAINA, AI solution, launched
- 2017** Started the provision of the identity verification service "e-NINSHO" using My Number

Process of Value Co-Creation

NRI will provide the optimal services to resolve clients' issues through its consulting services and solutions services. The social value created through value co-creation with clients not only contributes to the creation of a prosperous future society but also further enhances NRI's competitive advantage and achieves sustainable growth.

Dream up the future

NRI's 3 Social Values → P.50

Co-create a thriving future society
by driving new value.

Co-create an ideal society
by effectively utilizing its resources.

Co-create a safe and secure society
by advancing its infrastructure.

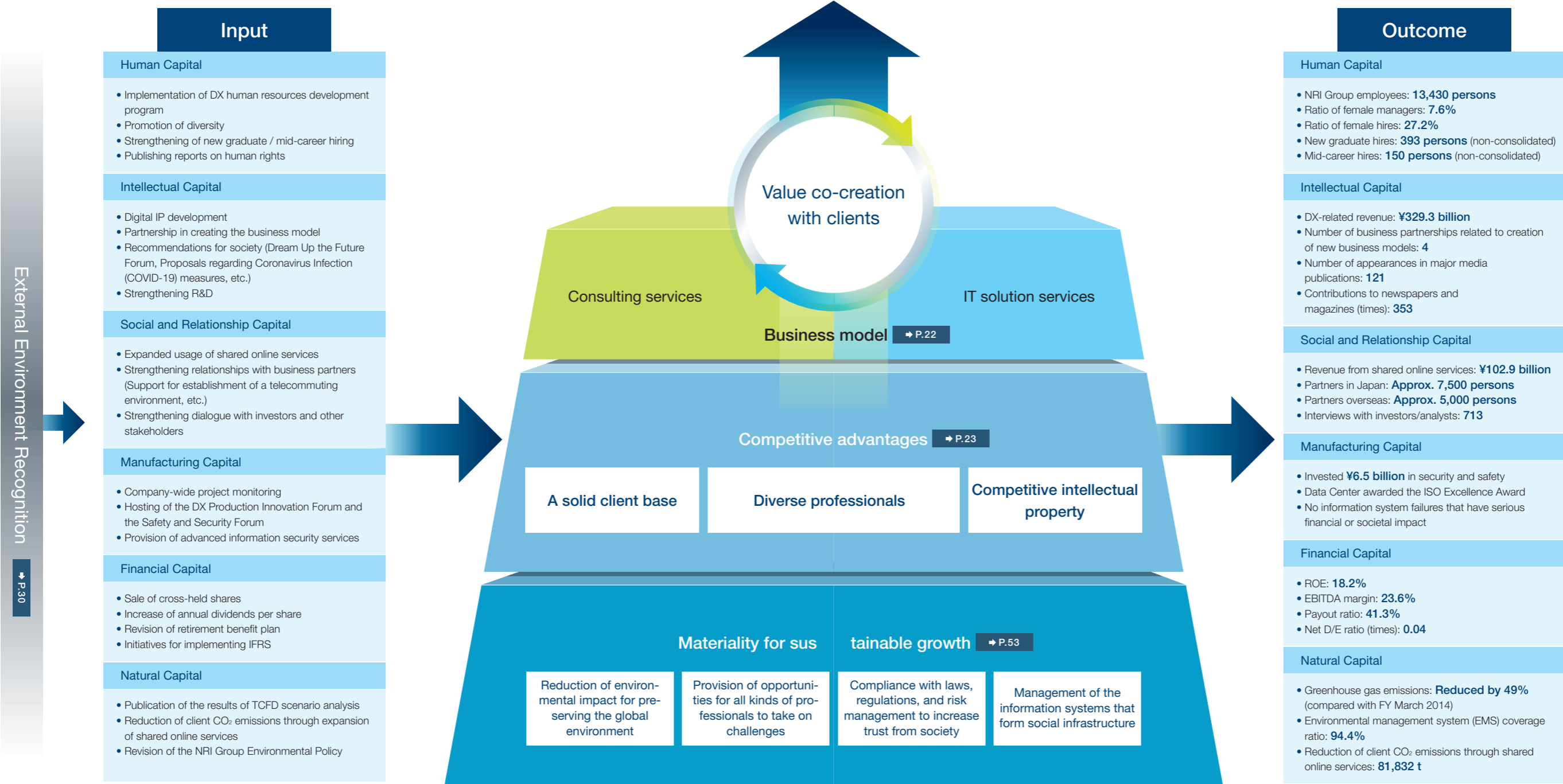

* Data is for FY March 2021 or as of the end of March 2021.

* Data is for FY March 2021 or as of the end of March 2021.

Business Model

NRI has a consulting function that guides solutions from the stage of problem finding and an IT solutions function that realizes problem solving through system development and operation, and has accumulated related experience and knowledge over a long period of time. NRI combines these two functions to develop two types of unique business models that cannot be easily realized by other companies.

Consulting

With one of Japan's largest consulting divisions, NRI possesses expert consulting capabilities for various industries and operating processes. As a pioneer in Japan, we have contributed to the development of society, industry, and corporations for many years. Our diverse and highly specialized consultants support the transformation of our clients based on the experience and know-how accumulated through long-term business relationships.

IT Solutions

System engineers capable of fully utilizing the latest technology will achieve transformation of clients through systems. In particular, NRI's greatest area of expertise is the financial industry, where we provide solutions to many clients. NRI's IT solutions anticipate cutting-edge technology, and strategically incorporate that technology into solutions for provision.

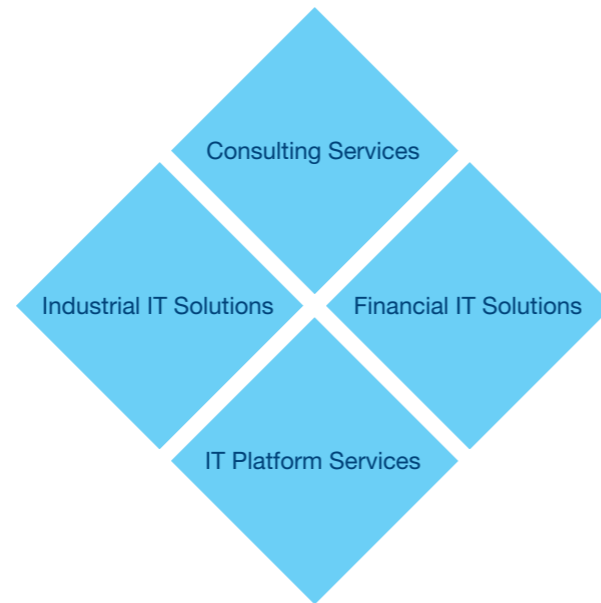

Navigation × Solution

Providing Value by Combining Navigation and Solutions

This model provides consulting that guides clients from problem discovery to solutions, and integrates all phases to the solution of problems through IT solutions. In this way, the model responds accurately to client needs.

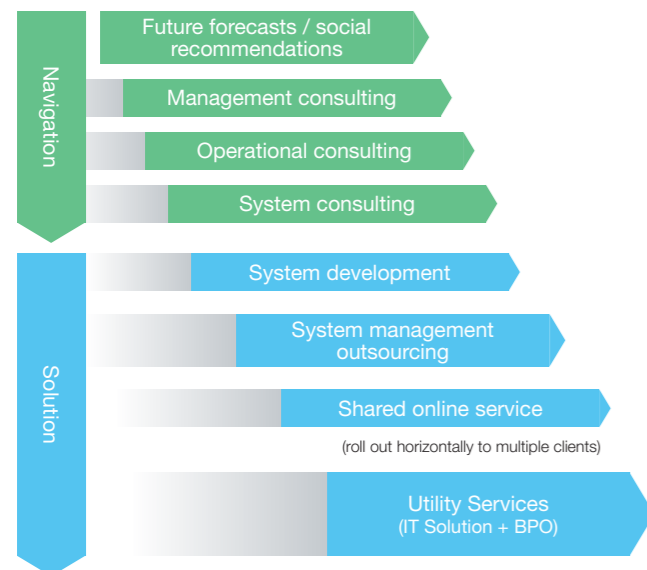

Con-Solution

Consulting and IT Solutions Run Side-by-Side With Clients to Provide Continuous Value

This business model is run side-by-side from the planning and concept stages. The model creates and promotes business while repeating the process of hypothesis testing. In this way, we co-create business value with clients and heighten that value.

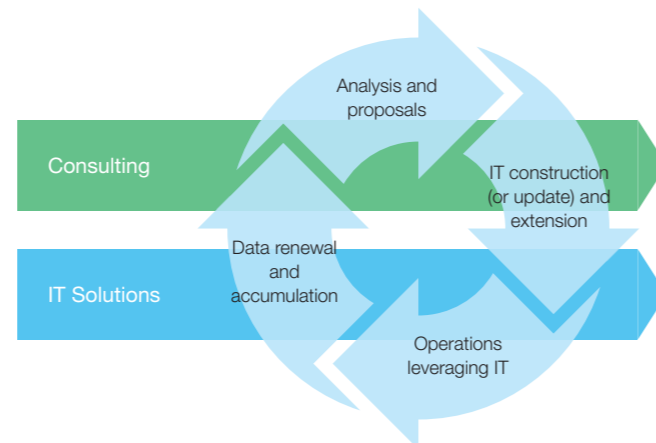

Competitive Advantages

Solid Client Base

The experience and expertise accumulated through NRI's long-lasting business relationships with industry leaders are important assets for the Company. The increase in the number of clients using system management and operation outsourcing or shared online services contributes not only to the expansion of NRI's business but also to the stabilization of its profit structure.

Competitive Advantages of Social and Relationship Capital

NRI has accumulated its expertise through long-term business relationships with industry leaders. Moreover, by providing shared online services based on that expertise, we have established more sustainable business relationships with more of our clients.

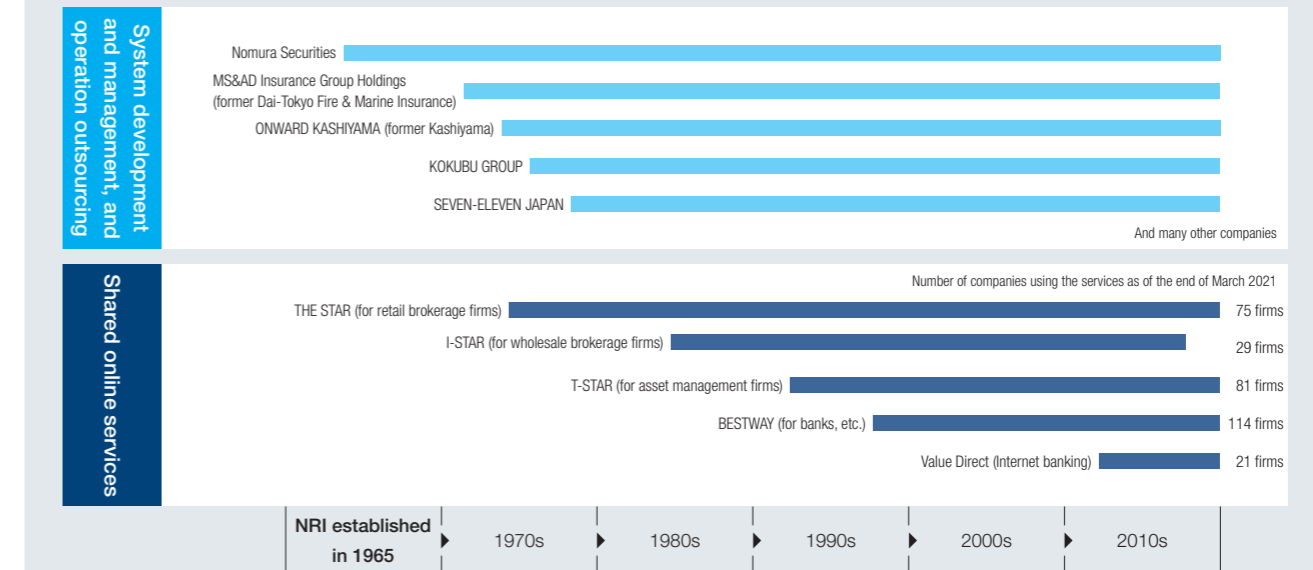

Stable Profit Structure

NRI has established a stable profit structure with sustainable businesses accounting for over 60%, such as shared online services, system management, and operation outsourcing, as well as enhancements (maintenance and operations) in system development.

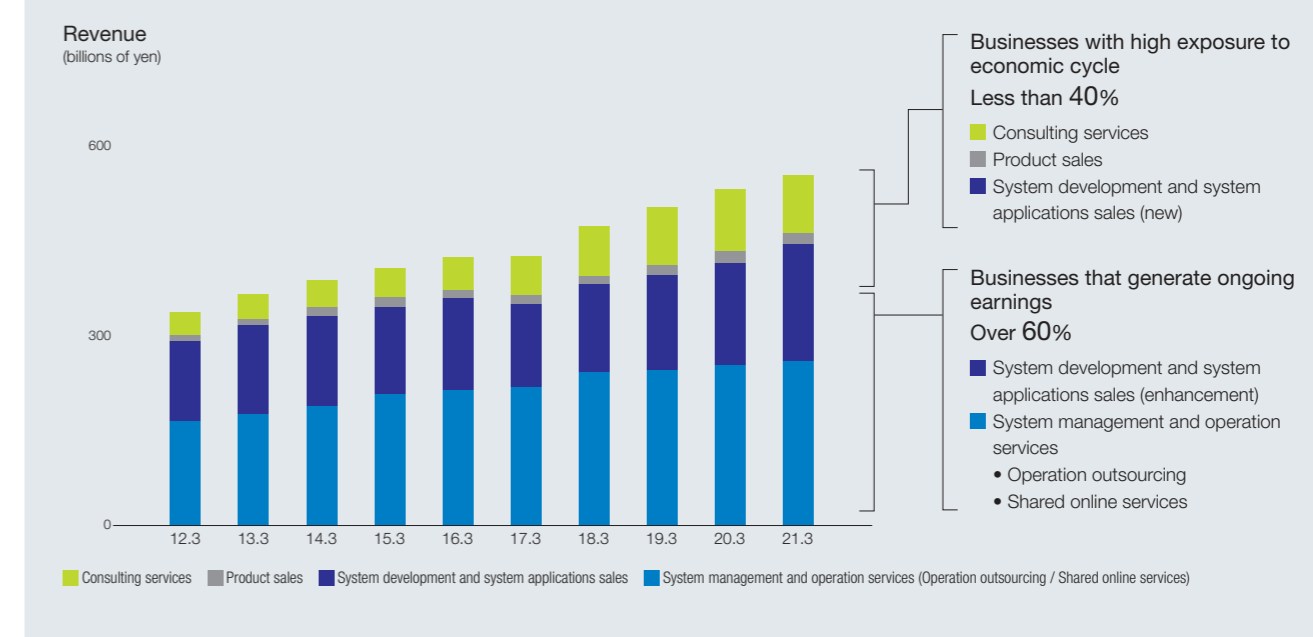

Competitive Advantages

Diverse Professionals

NRI's human resources exceed other companies' levels in the industry in terms of both quality and quantity, and NRI is further improving its human resources by providing them with various opportunities to grow. As a result, NRI maintains high levels of profitability and productivity in the IT service industry.

Competitive Advantages of Human Capital

NRI provides services in cooperation with employees at its domestic and overseas bases. NRI also has an abundance of professionals with advanced information technology, skills, etc.

Number of NRI Group Employees and Employees at Overseas Bases (persons)

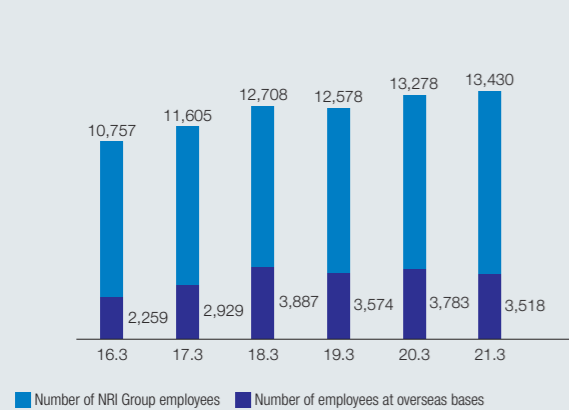

Number of Qualified Professionals (persons)

(Non-consolidated data)	19.3	20.3	21.3
Information Technology Engineers Examination (Advanced)*1	6,726	6,856	6,824
IT Coordinator	207	240	254
Project Management Professional	299	320	336
ITIL Manager/Expert/Intermediate	70	68	77
Chartered Member of the Securities Analysts Association of Japan	245	246	246
Certified Public Accountant	16	15	12
SME Management Consultant	46	48	46
First-Class Registered Architect	10	10	10
Chief Telecommunications Engineer	107	108	86
Public Cloud-Related Certification*2	94	543	1,442

*1 The Information Technology Engineers Examination is a certification examination administered by the Information-technology Promotion Agency, an independent administrative institution, which is a testing institution designated by the Minister of Economy, Trade and Industry. The figures include the numbers of persons who have passed the "System Analyst Examination," "Senior Systems Administrator Examination," "Information Security Specialist Examination," and "Information Systems Security Administrator Examination," which were administered under the previous system.
*2 Total number of people with AWS certification, Google Cloud (GCP) certification, and Microsoft Certified (Technology Azure).

High Levels of Profitability and Productivity

NRI maintains top-level profitability (consolidated operating margin and EBITDA margin) as well as productivity (consolidated revenue and operating profit per employee) compared with competitors both in Japan and overseas.

Industry-wide Comparison of Consolidated Revenue and Operating Margin (FY Mar. 2021)

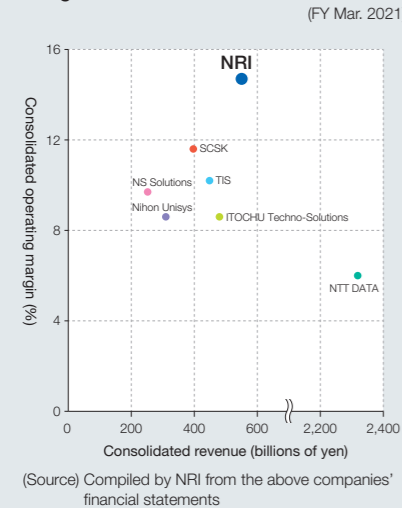

Industry-wide Comparison of Consolidated Revenue and Operating Profit per Employee (FY Mar. 2021)

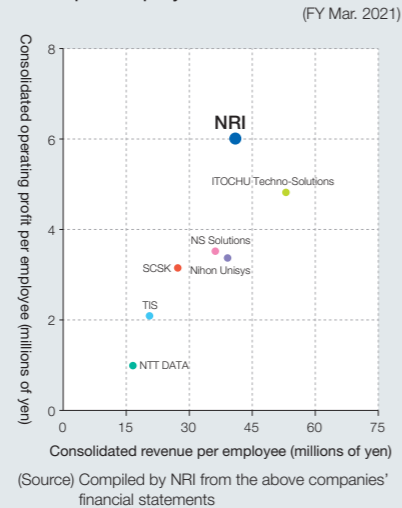

EBITDA Margin Comparison (%)

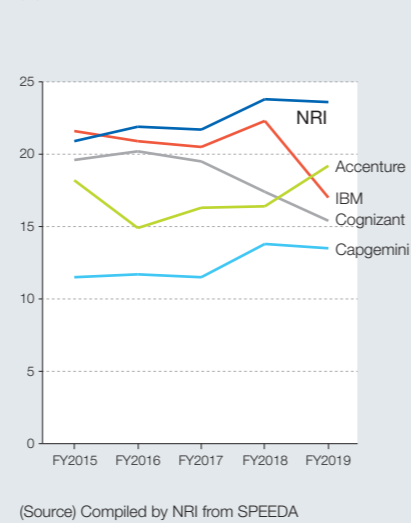

Competitive Advantages

Competitive Intellectual Property

We promote research and development (hereinafter, "R&D") with high-quality investigation ability and systems in order to create value unique to NRI with innovations and building sustainable futures by solving social issues.

Competitive Advantages of Intellectual Capital

NRI widely communicate the fruits of R&D to society as future forecasts and recommendations related to society. At the same time, they are integrated with existing expertise that was obtained through business activities and utilized as practical competitive intellectual properties.

Future Forecasts and Social Recommendations

Ever since its founding, NRI has continued activities as a think tank, such as the provision of future forecasts and social recommendations. The Company carries out investigative research in industry fields such as finance, distribution and IT, surveys of consumer trends, and future forecasts. The results are widely communicated to society through the publication of books, symposiums, magazines, newspapers, television, and other mass media.

A great number of such results have been picked up by various media and book reviews, and have been highly recognized by various quarters. We believe that such activities are contributing greatly to the enhancement of NRI's corporate brand image.

Books written by NRI employees



Development of Competitive Intellectual Properties

Based on expertise acquired through transactions with top-class companies in the industry, and knowledge obtained through R&D activities, we are developing competitive intellectual properties that can be used widely in business. In recent years, in particular, we have been focusing our efforts on the development of digital IPs, including cloud infrastructures and algorithms, which can be used for multiple clients and industries in the DX business area. By having a number of digital IPs available, we would be able to provide high-quality IT solutions in a shorter amount of time, thereby contributing to the strengthening of NRI's competitive advantage.

Going forward, we will continue making investment in research for the development of digital IPs.

Goal	Digital IP
Higher quality, higher performance, and better productivity through standardization and breakdown into components	Cloud infrastructure such as IoT and AI
Commercialize high value-added analysis models	Standardized components for e-commerce
	Algorithms based on data analytics

Advanced R&D

NRI promotes two categories of R&D. The first is business development, via research and feasibility investigations, prototype development, and proof of concepts for new business and new product development according to our Medium-Term Management Plan and "Vision2022" Long-Term Management Vision. The second is investigative research, via cutting-edge technological research, fundamental technologies, and production/development technologies regarding information technology, and recommendations for society, via surveys and research.

In FY March 2021, we invested ¥4.4 billion in R&D and placed particular emphasis on business development themes and accumulated commercialization expertise for businesses that will lead to new value creation.

R&D Themes and Initiative Policies

Theme	Initiative policy
Investigative research	• Research and theoretical research from a medium- to long-term perspective
	• Investigation research contributing to NRI business development
	• Technology trend surveys to contribute to the vitalization of business development and strengthen the technical competitiveness of NRI
	• Systematic policy research, consumer surveys, etc.
Business development	• Recommendations that contribute to government institutions and corporate management
	• Business development for priority themes such as 5G, next-generation stores, and smart cities
	• Technological research focusing on DX-related technology

Utilization of Capital

NRI utilizes its capital to create a variety of high value-added services. DX for corporations has been attracting attention in recent years. By fully utilizing capital that we have cultivated, we contribute to the realization of DX by co-creating value with clients.

Examples of Utilization in the Financial Field







Shared Online Services

Shared online services consist of the creation of software incorporating the technology and expertise cultivated through building systems for individual clients, with the client's required work standardized, and providing it as SaaS*.

Shared online services allow for greater cost reductions when compared with constructing a system for each company. It also alleviates the burden of adapting to regulatory revisions. As an industry pioneer, NRI has provided these services since the 1970s, even before the term "cloud" existed, and has been far ahead of its competitors, supporting the "shift from ownership to use" of information systems for about 50 years.

* A type of service in which software located on a private NRI cloud is provided via the Internet

Major Shared Online Services

 <p>Launched in 1974 THE STAR Back-office solution for retail brokerage firms</p>	75 firms	 <p>Launched in 1997 BESTWAY Back-office solution for mutual fund sales at banks * Including life insurance firms, non-life insurance firms, and investment trust firms, etc.</p>	114 firms*
 <p>Launched in 1987 I-STAR Back-office solution for wholesale brokerage firms</p>	29 firms	 <p>Launched in 2012 Value Direct Online banking system</p>	21 firms
 <p>Launched in 1993 T-STAR Back-office solution for asset management firms</p>	81 firms	 <p>Launched in 2015 e-BANGO My Number management services</p>	No. of My Number stored Approx. 26 million cases

Note: No. of firms and cases are as of the end of March 2021.

Utility Services (IT solutions + BPO services)

Utility services are provided in combination with NRI's IT solutions such as shared online services and BPO services.

NRI provides the entire business process with the personnel who handle related work, not just the system.

Major Utility Services

For retail brokerage firms

NRI provides the shared online service "THE STAR," and DSB Co., Ltd., provides comprehensive support services. They range from trade execution, clearing, settlement, account management, account transfer, and other financial services carried out on behalf of securities companies, to securities back-office works, printing, envelope insertion, and mailing services.

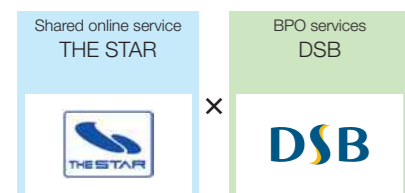

For asset management firms (investment trust and investment advisory firms)

NRI provides the shared online service "T-STAR," and NRI Process Innovation, Ltd., provides the overall middle/back-office work, such as net asset value calculation for asset management firms (investment trusts and investment advisory firms, etc.) and other investment trust accounting work and investment report creation work.

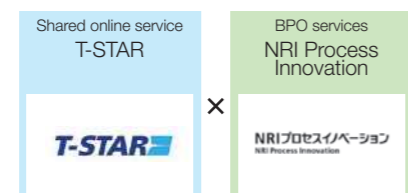

For financial institutions / operating companies

NRI provides "e-BANGO" as a My Number storage/management system with high management standards, based on our experience operating backbone systems for financial institutions. DSB Co., Ltd., provides services for the collection, registration, management, and use of individual numbers.



Examples of Utilization of DX for the Industrial Field

In response to the increasing number of DX initiatives by clients in recent years, NRI is accumulating and utilizing cloud infrastructure, data analytics, and other common functions that can be used across clients and industries as intellectual assets called "digital IP." The use of digital IP enables us to provide our clients with high-quality systems in a short period of time.

Furthermore, NRI's unique business model Con-Solution enables clients, NRI consultants, and system engineers to work together to repeat the process of strategy planning, implementation, and sophistication in a short period of time. Even after the start of business, NRI supports the growth of our clients by using the same process to quickly respond to their ceaselessly changing business needs and to constantly optimize their business.

This kind of co-creation with clients is an initiative that can only be achieved by NRI as a company possessing both consulting and IT solution functions.

Image of Con-Solution initiatives

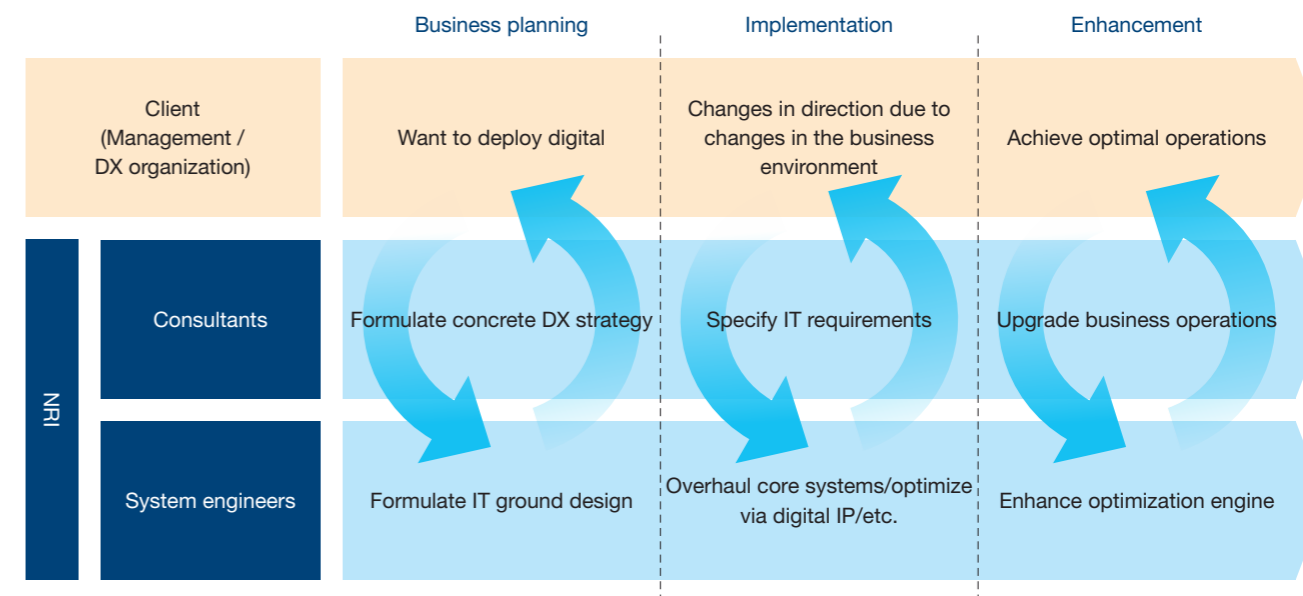







The NRI Dream Up the Future Forum 2020

On October 5, 2020, we held the NRI Dream Up the Future Forum 2020 at the Tokyo International Forum. Based on its corporate philosophy of "Dream up the future," NRI holds the forum every year with the objective of discussing the future vision of Japan and the world.

At Future Forum 2020, NRI Chairman and President & CEO Shingo Konomoto gave a lecture entitled "Development of Digital Social Capital for the Post-Corona Era." He pointed out that the spread of working from home has increased people's disposable income and created more free time. President Konomoto also discussed how more time spent online due to dramatic behavioral changes has resulted in more free space. Furthermore, he explained that these paradigm shifts are beginning to create unprecedented new demand. President Konomoto reiterated that national and local governments must continue initiatives from 2019 to transition from traditional industrial social capital that emphasizes quantitative growth of industry to digital social capital that emphasizes the affluence of people's lives.



NRI's Capital and the Creation of Value through its Utilization

	 Human Capital	 Intellectual Capital	 Social and Relationship Capital		 Manufacturing Capital	 Financial Capital	 Natural Capital
Importance of various types of capital in value creation	Diverse professionals from Japan and overseas who have advanced expertise, play an active role and lead the way in all value creation	Creation of new value through accumulation of cutting-edge intellectual capital and innovation, on the foundation of knowledge acquired through high-quality investigation/research activities and business	Creation of stable, sustainable value through a solid client base focused on companies that are at the top of their industries, expansion of shared online services, and strengthening of relationships with business partners and other stakeholders		Contribution to the increased sophistication of social infrastructure and co-creation of safe and secure social infrastructure through high-quality services that have been certified/guaranteed by third-party organizations	Achievement of both growth and shareholder returns through capital reserves and a high level of capital efficiency that enable flexible investment, in addition to the creation of a solid financial base	Contribution to maintenance of the global environment by reducing the environmental burden through appropriate management of energy consumption at data centers
Medium- and long-term strengthening policy	<p>Strengthening of hiring (FY2019-FY2022: Increase of more than 1,000 persons; non-consolidated)</p> <ul style="list-style-type: none"> Bolster new graduate hiring: Bolster promotions, etc. Bolster mid-career hiring: Further improve systems of working conditions for the hiring of more specialists, etc. <p>Promote employee skills transfer and development</p> <ul style="list-style-type: none"> Strategic development of specialists in the DX area Skills transfer and development for application/platform personnel to support DX strategy <p>Promote employee success</p> <ul style="list-style-type: none"> Promote diverse work styles (diversity, participation, and advancement of women and senior personnel) Initiatives to respect human rights 	<p>Digital IP development</p> <ul style="list-style-type: none"> Digital IP development that contributes to improvement of competitiveness in the DX area <p>Investment in business development</p> <ul style="list-style-type: none"> R&D regarding new business development in the medium to long term (business discovery, incubation, etc.) R&D for DX utilization positioned as important themes, such as artificial intelligence (AI), IoT, and fintech <p>Promotion of recommendations for society</p> <ul style="list-style-type: none"> Recommendation activities related to the impact of digitalization and other environmental changes on society 	<p>Business Platform Strategy</p> <ul style="list-style-type: none"> Expansion of existing shared online services and other core businesses Launch of new platform services in preparation for entry of companies from other industries into financial business <p>Strengthening relationships with business partners in Japan and overseas</p> <ul style="list-style-type: none"> Creation of long-term, stable cooperative relationships with domestic and overseas business partners <p>Strengthening of social activities</p> <ul style="list-style-type: none"> Enhancement of opportunities to engage in dialogue with stakeholders Enhancement of activities to develop human resources and society 		<p>Improvement of information system quality</p> <ul style="list-style-type: none"> Continued strengthening of project supervision activities Emphasis on quality of systems in operation Emphasis on operation quality of data centers <p>Strengthening of quality of information security</p> <ul style="list-style-type: none"> Improve the sophistication of security management framework Information Security Training Response to cyberattacks 	<p>Achievement of a solid financial base and strong medium- to long-term growth</p> <ul style="list-style-type: none"> Ensuring a level of financial soundness that is suitable for a company that supports the social infrastructure Ensuring the ability to generate cash flows to support growth investment (EBITDA margin: 20% or higher) Maximum Net D/E ratio (times): 0.3 <p>Capital efficiency to achieve both growth and return</p> <ul style="list-style-type: none"> Improve capital efficiency: Awareness of the European/U.S. level (20% level) Improve returns to shareholders: Aim for a payout ratio of 35% <p>Improvement of financial management/disclosure with an awareness of global standards</p> <ul style="list-style-type: none"> Consideration of implementation of IFRS 	<p>Environmental management based on global standards</p> <ul style="list-style-type: none"> Reduction of greenhouse gas emissions (Target for FY March 2031: 72% (compared with FY March 2014)) Use of renewable energy at data centers (Target for FY March 2031 70%) Implementation of Environmental Management System (EMS) Innovative approach to TCFD recommendations (Evaluation of the impact of climate change on business) <p>Generation of environmental benefits for clients through expansion of shared online services</p>
Main initiatives of FY March 2021 (Input)	<ul style="list-style-type: none"> Strengthening of the implementation of the human resources development program to support DX strategy Initiatives to promote diversity (Supporting training for balancing work and parenting, etc.) Developed an office environment that promotes work-style reform and internal/external interactions Enhance hiring of new graduates and mid-career hires Formulation of the NRI Group Human Rights Report 	<ul style="list-style-type: none"> Digital IP development (cloud infrastructure IP, standardized parts for the EC, algorithm IP) Search for and development of priority themes that lead to new businesses in the DX area Promotion of partnerships in preparation for the creation of business models Hosting of the Dream Up the Future Forum Released NRI's Proposals regarding Coronavirus Infection (COVID-19) measures Enhance R&D expenses 	<ul style="list-style-type: none"> Expansion of the number of companies using shared online services aimed at co-creation of the ideal society Support for establishment of a telecommuting work environment at business partners Dialogue with investors through overseas roadshows, dialogue with stakeholders, etc. Hosting of ESG Briefings and Business Information Sessions Hosting of the 2020 NRI Student Essay Contest 		<ul style="list-style-type: none"> Company-wide project watching through project monitoring activities Hosting of the DX Production Innovation Forum Hosting of the Safety and Security Forum Implementation of information security training Provision of advanced information security services 	<ul style="list-style-type: none"> Partial sale of cross-held shares Increase of annual dividends per share Revision of retirement benefit plan Initiatives for implementing IFRS 	<ul style="list-style-type: none"> Publication of the results of TCFD scenario analysis targeting consulting business and asset management business Reduction of client CO₂ emissions through expansion of shared online services Revision of the NRI Environmental Target Revision of the NRI Group Environmental Policy Issuance of NRI Sustainability-Linked Bond
Results of FY March 2021 (Outcome)	<ul style="list-style-type: none"> NRI Group employees: 13,430 persons Ratio of female managers: 7.6% Ratio of female hires: 27.2% Selected as a Nadeshiko Brand listed company for five consecutive years with outstanding promotion of female performance and advancement Certified as a Health and Productivity Management 500 Organization 2020 (White 500) for five consecutive years No. of hires: New graduates: 393 persons; mid-career: 150 persons 	<ul style="list-style-type: none"> DX-related revenue of ¥329.3 billion (Ratio of revenue from consolidated: 59%) Number of business partnerships related to creation of new business models: 4 Number of appearances in major media publications: 122 Contributions to newspapers and magazines (times): 290 	<ul style="list-style-type: none"> Revenue from shared online services: ¥102.9 billion Number of companies using the shared online service THE STAR: 75 companies Partners in Japan: Approx. 7,500 persons Partners in China: Approx. 5,000 persons Results of the Client Satisfaction Survey (non-consolidated): 86.4%* Individual interviews with investors/analysts: total of 713 <p>* Percentage that responded "satisfied" or "moderately satisfied" (Total for top two items on five-grade scale)</p>		<ul style="list-style-type: none"> Invested ¥6.5 billion in security and safety Data Center awarded the ISO Excellence Award NRI SecureTechnologies, Ltd., received the Japan Managed Security Service Provider of the Year award for three consecutive years No information system failures that have serious financial or societal impact 	<ul style="list-style-type: none"> ROE: 18.2% EBITDA margin: 23.6% Payout ratio: 41.3% Net D/E ratio (times): 0.04 S&P Global Rating: A (Maintained since September 2018) 	<ul style="list-style-type: none"> Greenhouse gas emissions: Reduced by 49% (compared with FY March 2014) Environmental management system (EMS) coverage ratio: 94.4% Reduction of client CO₂ emissions through shared online services: 81,832 t Selection by CDP to be on the Climate Change A List based on NRI's innovative efforts related to climate change Placement on the Leaderboard of CDP's Supplier Engagement Rating based on NRI's efforts regarding climate change in the supply chain

Opportunities and Risks due to Changes in the External Environment

Based on an understanding of changes in the external environment and opportunities/risks for NRI, we formulate policies for continuing sustainable growth and implement related initiatives.

	Main changes to the external environment	Opportunities	Risks	Related Initiatives
Japan	<p>Decreasing Population/Work-Style Reform</p> <p>There are concerns that a decreasing labor pool due to a low birthrate and an aging population will reduce the competitiveness of Japanese companies. Meanwhile, efforts toward work-style reform in an aim to rectify long working hours and increase labor productivity in Japanese companies are continuing. In particular, the need to respond to COVID-19 is accelerating the rethinking of work style through working from home.</p> <p><small>* The population estimate issued by the Statistics Bureau of the Ministry of Internal Affairs and Communications decreased by 3.6% in 2020.</small></p>	<ul style="list-style-type: none"> • Expansion for Usage of IT Services <ul style="list-style-type: none"> • Heightened needs for increasing business efficiency and improving productivity • Shift to shared online services • Modernization of systems by using new technology • Improvement of Productivity Through Work-Style Reform <ul style="list-style-type: none"> • Pursuit of optimal work style for NRI through use of methods such as working from home 	<ul style="list-style-type: none"> • Securing/Cultivating Human Resources <ul style="list-style-type: none"> • Insufficient securing and cultivating of human resources possessing expertise • Decrease in labor productivity, outflow of human resources • Business Partners <ul style="list-style-type: none"> • Insufficient securing of business partners with highly specialized business know-how • Decline in productivity and quality in the NRI Group, including business partners 	<p>Diverse Professionals → P.24 NRI's Human Resources Strategy → P.58 Development of DX Human Resources → P.60</p> <p>Cooperation with Business Partners → P.65 NRI's Quality Management → P.68</p>
	<p>The Evolution of IT and its Increased Use</p> <p>Advances in IT are giving birth to new digital technologies such as artificial intelligence (AI) and the IoT, and leading to the rapid digitalization of society. A digital transformation (DX) that transforms business utilizing new IT is currently under way. In particular, it is anticipated that efforts to rethink business models using IT to respond to the spread of COVID-19 will move forward.</p>	<ul style="list-style-type: none"> • Expansion of Client Base <ul style="list-style-type: none"> • Needs for simultaneous transformation of client business and IT by connecting consulting and IT solutions • Emergence of DX-Related Business <ul style="list-style-type: none"> • R&D for advanced themes with a focus on DX-related business • Emergence of business by accumulating know-how through collaboration with clients 	<ul style="list-style-type: none"> • Quality <ul style="list-style-type: none"> • Occurrence of large-scale system failures • Unstable operation of the operating system • Projects <ul style="list-style-type: none"> • Late delivery • Work man-hours exceeding the initial estimate 	<p>Competitive Intellectual Property → P.25 NRI's Quality Management → P.68</p>
	<p>Increase in Cyberattacks</p> <p>The number of cyberattacks observed by NICTER was about 500.1 billion in 2020. This is an increase of 3.3 times from three years ago. About half of cyberattacks target IoT devices. This poses a threat to the progress of DX.</p>	<ul style="list-style-type: none"> • Strengthening of Information Security <ul style="list-style-type: none"> • Needs for information security services for safe and secure management of data such as personal information • Needs for advisory services by experts due to lack of information security specialists 	<ul style="list-style-type: none"> • Information Security <ul style="list-style-type: none"> • Information leakage due to unauthorized access from outside • Rule violations at the NRI Group and business partners 	<p>Cooperation with Business Partners → P.65 Quality of Information Security → P.70</p>
Japan Overseas	<p>Increase in Seriousness of Social Issues</p> <p>Social issues such as climate change are becoming more serious on a global scale. There is an even greater need for international initiatives aimed at resolving social issues; for example, the Paris Agreement and the United Nations Sustainable Development Goals (SDGs). As globalization and networking of business activities continues to increase, the scale of damage expected in the unlikely event of a disaster or system failure is increasing.</p>	<ul style="list-style-type: none"> • Contribution to Preserving the Global Environment <ul style="list-style-type: none"> • Reduction of client greenhouse gases through shared online services • Business Continuity in State of Emergency <ul style="list-style-type: none"> • Needs for data centers that possess advanced disaster functions • Initiatives for Resolving Social Issues <ul style="list-style-type: none"> • Response to decarbonization and carbon neutral • Response to resource conservation and circular economy • Response to agriculture reform and food value chain 	<ul style="list-style-type: none"> • Social Responsibility <ul style="list-style-type: none"> • Insufficient contribution to global environmental preservation • Inappropriate behavior in business activities • Business Continuity <ul style="list-style-type: none"> • Lack of preparation for COVID-19 and large-scale natural disasters 	<p>Environmental Impact Reduction Activities for Preserving the Global Environment → P.72 Initiatives for the TCFD Final Report → P.74 Internal Controls, Corporate Ethics, and Compliance → P.88</p> <p>Cooperation with Business Partners → P.65 NRI's Quality Management → P.68</p>
	<p>Strengthening the Protection of Rights</p> <p>Regulations for protecting rights such as intellectual property rights and personal information are becoming stronger.</p>	<ul style="list-style-type: none"> • Prevention of Legal Violations and Serious Accidents <ul style="list-style-type: none"> • Needs for advisory services for the practice and establishment of protecting rights 	<ul style="list-style-type: none"> • Compliance <ul style="list-style-type: none"> • Infringement on the intellectual property rights of a third party • Violation of domestic and foreign laws and regulations 	<p>Internal Controls, Corporate Ethics, and Compliance → P.88</p>
	<p>Increase in Complexity of the Global Value Chain</p> <p>Given the trends of geopolitical changes and the increased complexity of factors requiring consideration, demand is increasing for the construction of sustainable and highly reliable value chains.</p>	<ul style="list-style-type: none"> • Reconstruction of Value Chain <ul style="list-style-type: none"> • Needs for advisory services for corporations reconstructing the global value chain 	<ul style="list-style-type: none"> • Partners <ul style="list-style-type: none"> • Risks and reduced efficiency for offshore development overseas 	<p>Cooperation with Business Partners → P.65</p>
	<p>Relative Expansion of Scale of Overseas Market</p> <p>The GDP growth rate of developed countries/regions is expected to recover from -4.6% in 2020 to 5.6% in 2021 and 4.4% in 2022. The GDP growth rate of Japan is expected to recover from -4.7% in 2020 to 2.8% in 2021 and 3.0% in 2022. This means that relatively low growth is expected to continue in Japan.</p> <p><small>* Figures are excerpted from the IMF World Economic Outlook July 2021.</small></p>	<ul style="list-style-type: none"> • Entry into Overseas Markets <ul style="list-style-type: none"> • Initiatives for IT investment needs in overseas markets • Acquire competitive IP overseas 	<ul style="list-style-type: none"> • Group Governance <ul style="list-style-type: none"> • Insufficient synergy through M&A and alliances • Insufficient system to promote global strategy 	<p>Global Strategy → P.42 NRI's Corporate Governance → P.80</p>

Financial Highlights

Shareholder Value / Returns to Shareholders

Earnings per Share (EPS)^{*2*}
(yen)

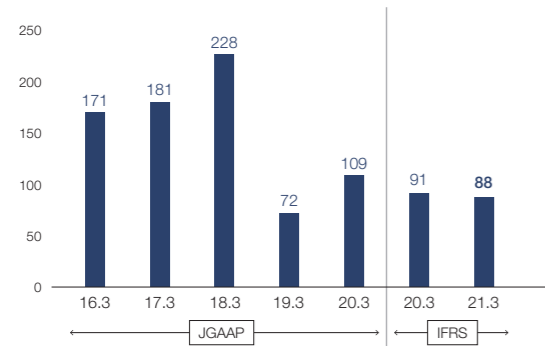

Cash Dividends per Share (DPS)^{*3} / Dividend Payout Ratio^{*4} / Total Return Ratio
(yen)

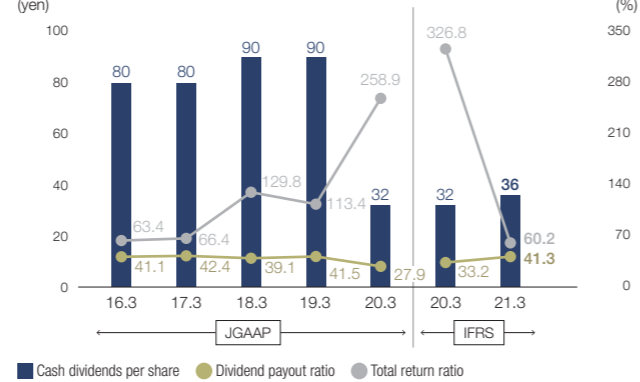

Cash Flows (CF)
(billions of yen)

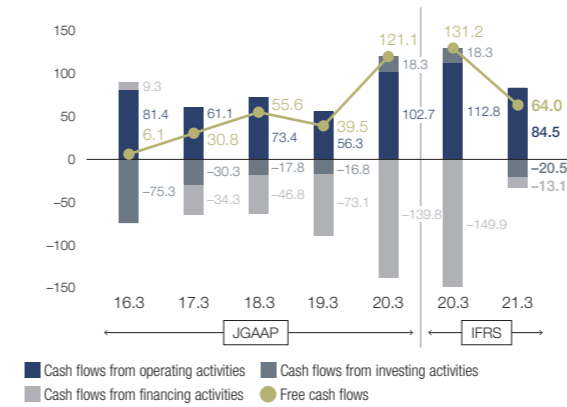

EBITDA^{*6} / EBITDA Margin
(billions of yen)

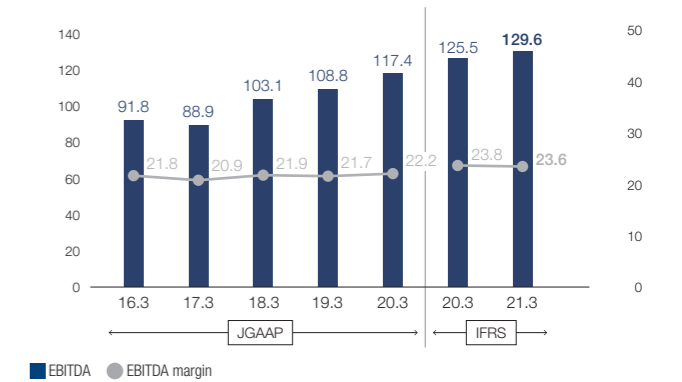

Financial Condition

Total Assets / Net Assets / Equity Ratio
(billions of yen)

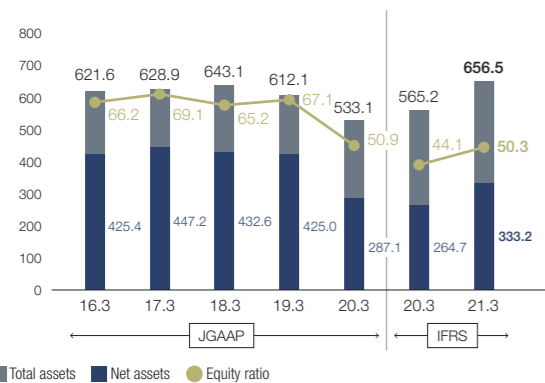

Interest-bearing Debt / Gross D/E Ratio
(billions of yen)

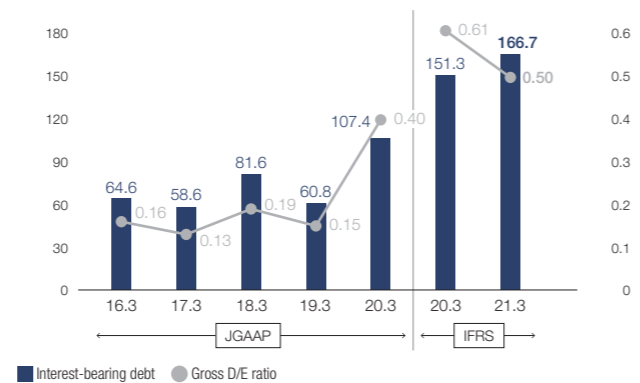

ROE / ROA
(%)

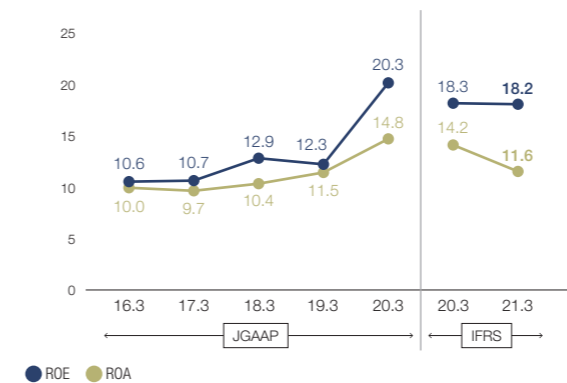

Financial Results and Cash Flow Situation

Revenue / Overseas Revenue^{*5} / Overseas Revenue Ratio
(billions of yen)

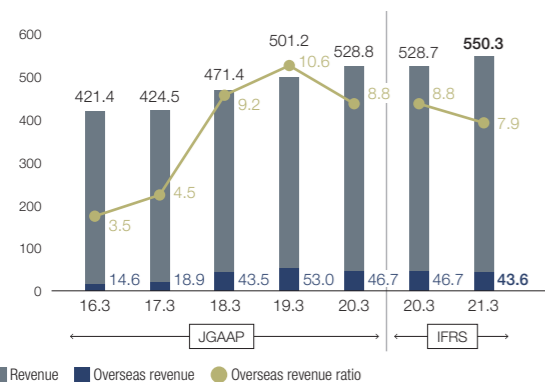

Operating Profit / Operating Margin
(billions of yen)

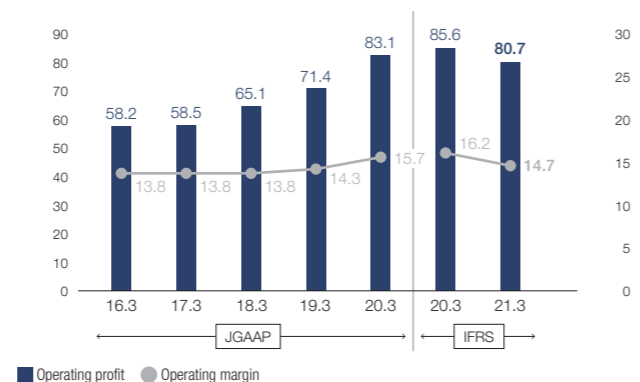

Investment Situation

Capital Expenditures / Depreciation and Amortization
(billions of yen)

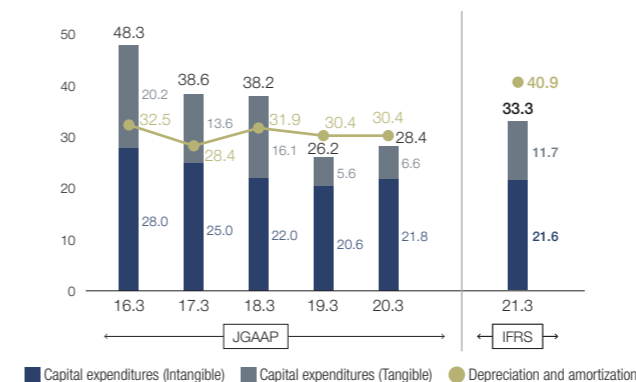

Research and Development Expenses
(billions of yen)

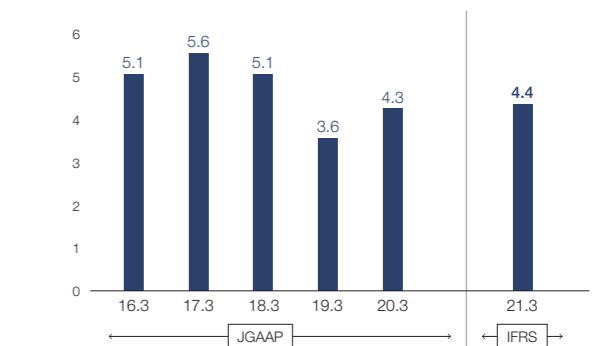

*1 Amounts have been rounded down to the nearest unit specified. However, percentages have been rounded off to the nearest digit specified.

*2 NRI implemented 1:1.1 common stock splits on January 1, 2017. EPS is calculated by deeming stock splits to have occurred respectively at the beginning of FY March 2015, and FY March 2016.

*3 NRI implemented 1:3 common stock splits on July 1, 2019. EPS is calculated by deeming stock splits to have occurred respectively at the beginning of FY March 2019. Dividend per share for FY March 2019 is based on the number of shares prior to the stock split.

*4 The dividend payout ratio is calculated by dividing the total sum of dividends (including dividends to the NRI Group Employee Stock Ownership Group) by net income.

*5 The method for calculating overseas revenue has been changed since FY March 2017.

*6 EBITDA is calculated as operating profit + depreciation and amortization + goodwill amortization up to FY March 2017, as operating profit + depreciation and amortization + goodwill amortization + loss on retirement of fixed assets from FY March 2018 and as operating profit + depreciation and amortization + loss on retirement of fixed assets ± temporary factors from FY March 2020 (IFRS).

Non-Financial Highlights

See P.106-107 for more details

E: Environment-related Data

Greenhouse Gas Emissions (NRI Group data)
(1,000t-CO₂)

The NRI Group reduced its greenhouse gas emissions significantly by migrating to new, environmentally friendly data centers and other means.

- FY March 2021: Reduced greenhouse gas emissions by 48.7% compared with FY March 2014.

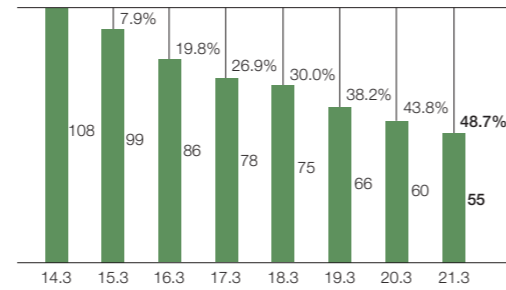

Green Revenues (Revenue from Shared Online Services)
(NRI Group data)

Amid concerns over rising power usage by the IT services industry as a whole, NRI has formulated a business plan intended to reduce power usage by the IT activities of the entire value chain, including client companies. Specifically, growing NRI's shared online service revenues will likely serve to curb the carbon dioxide emissions of society as a whole.

Data indicates that using NRI's shared online service can allow our clients to cut their CO₂ emissions by around 70%, compared with if they build and operate their own systems independently.

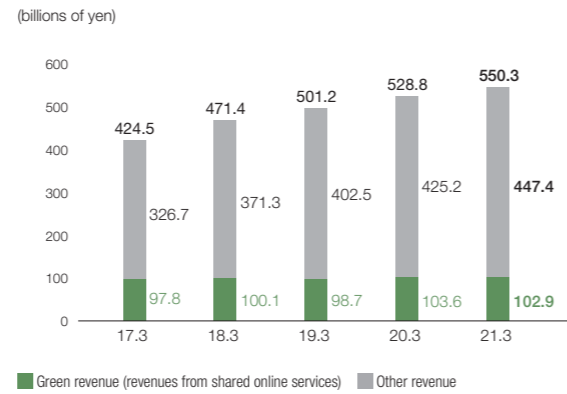

Female Hires' Ratio and Female Managers' Ratio
(Non-consolidated data)

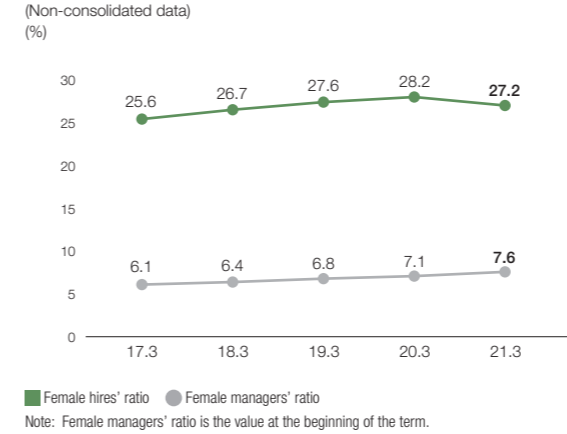

Childcare Leave / Nursing Leave (Non-consolidated data)

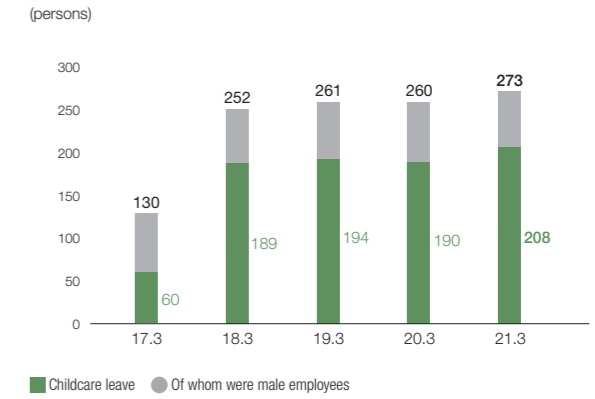

■ Female hires' ratio ● Female managers' ratio
Note: Female managers' ratio is the value at the beginning of the term.

■ Childcare leave ● Of whom were male employees

Monthly Average Overtime Hours per Employee
(Non-consolidated data)

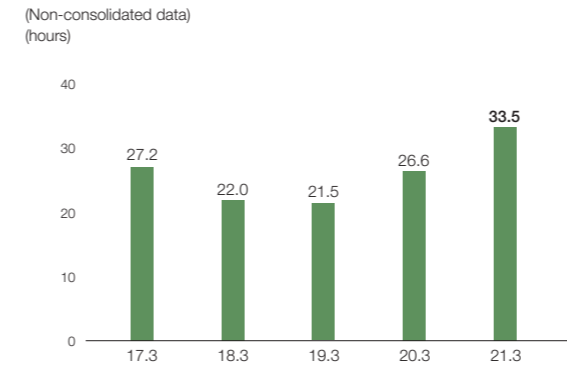

Information Communication / Recommendation Projects
(Non-consolidated data)

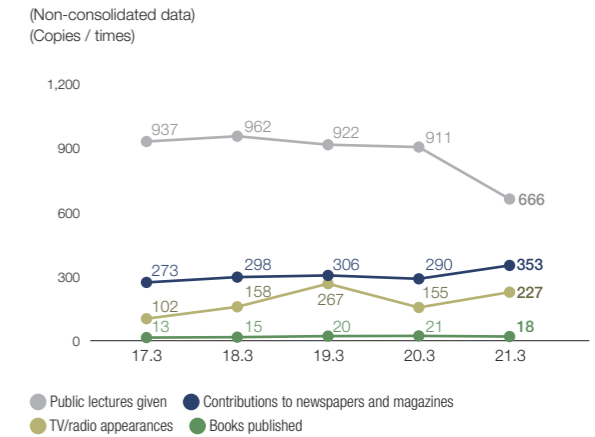

S: Social-related Data

Number of Employees (NRI Group data)

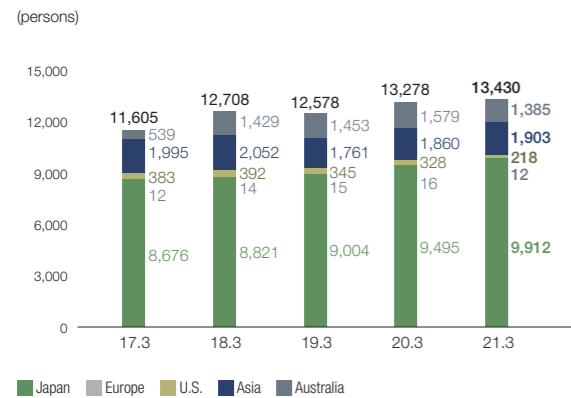

Number of Hires / Turnover Rate (Non-consolidated data)

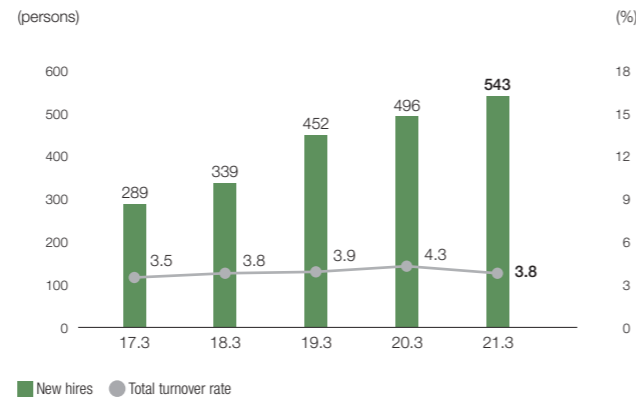

Client Satisfaction (Non-consolidated data)

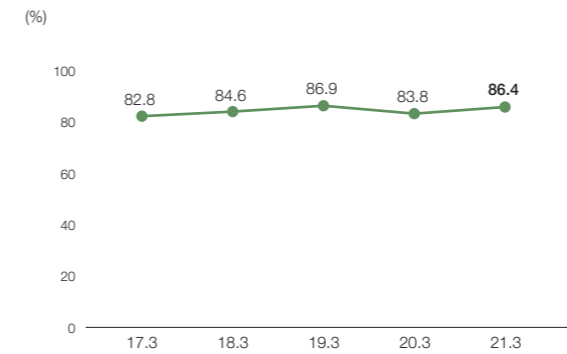

Employee Satisfaction (Non-consolidated data)

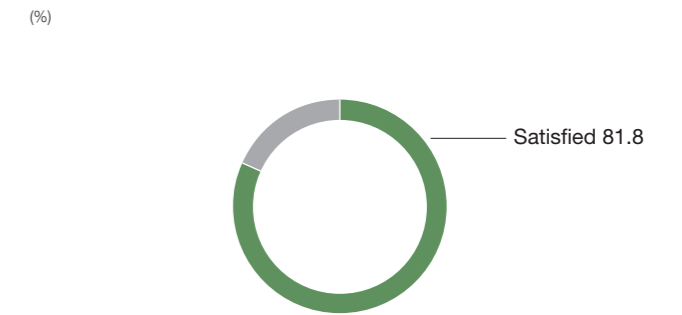

Note: Number of questionnaire responses by project unit that NRI received an order for. Percentage that responded "Satisfied" or "Moderately satisfied" (total for top two items on five-grade scale).

Note: Survey of NRI employees working in Japan every two years (as of July 1, 2019). Number of valid respondents: 5,706; collection rate: 83%. The ratio of employees thought to be satisfied is the ratio of "Satisfied" and "Moderately satisfied" on a four-level scale.

Looking Back on Past Medium-Term Management Plans

Vision2015 NRInnovation!		Vision2022 Share the Next Values!															
FY March 2009 – FY March 2016		Medium-Term Management Plan (2016–2018)		Medium-Term Management Plan (2019–2022)													
FY March 2009 – FY March 2016		FY March 2017 – FY March 2019		FY March 2020 – FY March 2023													
Objectives	To provide a business platform that laterally spans the industry and market	Expand the customer base and take on the challenge of new areas, including global and digital															
Strategy and main results	<ul style="list-style-type: none"> Growth higher than industry average and profitability set NRI apart in the industry <ul style="list-style-type: none"> Growth potential: 7% growth Profitability: 13% OPM or more Powerful business portfolio <ul style="list-style-type: none"> Break dependence on two major clients (Expand business from clients other than two major clients) 58%→74%* Expand business in industrial sector 19%→24%* Expand industry standard business platforms 12%→22%* Expand overseas-related business 1%→6%* 	<ul style="list-style-type: none"> Improve productivity in specialty areas in Japan <ul style="list-style-type: none"> Hardly any unexpected large-scale unprofitable projects Improved productivity by integrating business platform development systems and implementing development management integration tool Expand industry-standard business platforms and develop large-scale clients <ul style="list-style-type: none"> In Industrial IT, major progress has been achieved in the context of DX, and great progress has been made in development of large-scale clients In Financial IT, worsening business conditions of clients had an impact but business platforms grew, and large-scale projects were also acquired Expand number of clients to whom sales was ¥1 billion or more 64 firms→86 firms* Build foundations for global business <ul style="list-style-type: none"> Business in Australia is progressing smoothly, mainly with ASG Initiated more governance improvements in conjunction with global business expansion Create business IT <ul style="list-style-type: none"> More projects involving D2C, digital marketing, and analytics Greater proficiency in agile development for BiT, and productivity has improved Collaborative models have been achieved by establishing joint ventures 	<div style="display: flex; align-items: center; justify-content: space-between;"> <div style="writing-mode: vertical-rl; transform: rotate(180deg);">Growth Strategy</div> <div style="text-align: center;"> <div style="border: 1px solid black; padding: 5px; margin-bottom: 5px;">DX Strategy P.40</div> <div style="border: 1px solid black; padding: 5px; margin-bottom: 5px;">Business Platform Strategy P.41</div> <div style="border: 1px solid black; padding: 5px; margin-bottom: 5px;">Cloud Strategy P.41</div> <div style="border: 1px solid black; padding: 5px; margin-bottom: 5px;">Global Strategy P.42</div> <div style="border: 1px solid black; padding: 5px;">Human Resources Strategy P.44</div> </div> <div style="writing-mode: vertical-rl; transform: rotate(180deg);">Target</div> </div>		<table border="1"> <tr> <td>Revenue</td> <td>¥670 billion or more</td> </tr> <tr> <td>Operating profit</td> <td>¥100 billion</td> </tr> <tr> <td>Operating margin</td> <td>14% or more</td> </tr> <tr> <td>Overseas revenue</td> <td>¥100 billion</td> </tr> <tr> <td>EBITDA margin</td> <td>20% or more</td> </tr> <tr> <td>ROE</td> <td>14%*</td> </tr> </table>	Revenue	¥670 billion or more	Operating profit	¥100 billion	Operating margin	14% or more	Overseas revenue	¥100 billion	EBITDA margin	20% or more	ROE	14%*
Revenue	¥670 billion or more																
Operating profit	¥100 billion																
Operating margin	14% or more																
Overseas revenue	¥100 billion																
EBITDA margin	20% or more																
ROE	14%*																
Specific initiatives	<ul style="list-style-type: none"> Introduce THE STAR to Nomura Securities Co., Ltd. Established and acquired subsidiaries in the industrial field <ul style="list-style-type: none"> Acquired NRI System Techno, Ltd. (2012) Established Marubeni IT Solutions Inc. (2014) Acquired Brierley+Partners, Inc. (2015) Started provision of new industry standard business platform services <ul style="list-style-type: none"> Online banking system "Value Direct" Solution supporting financial institutions' retail sales representatives "Advisor Platform" STP platform solution for asset managers "SmartBridge Advance" My Number management services "e-BANGO" Established overseas bases <ul style="list-style-type: none"> Moscow, Dalian, India, Indonesia, and Thailand 	<ul style="list-style-type: none"> Expanding the number of companies using industry standard business platforms <ul style="list-style-type: none"> THE STAR: 68 firms→73 firms* BESTWAY: 109 firms→114 firms* T-STAR: 73 firms→75 firms* Global acquisition <ul style="list-style-type: none"> North America: Cutter Associates, LLC (2016) Australia: ASG Group Limited (2016), SMS (2017) Established joint ventures <ul style="list-style-type: none"> KDDI Digital Design Inc. (2017) Technium CO., LTD. (2018) NDIAS, Ltd. (2018) JAL Digital Experience Co., Ltd. (2019) 															

* All percentages (%) are the sales ratio from FY March 2008 to FY March 2016

* Number of firms from FY March 2016 to FY March 2019

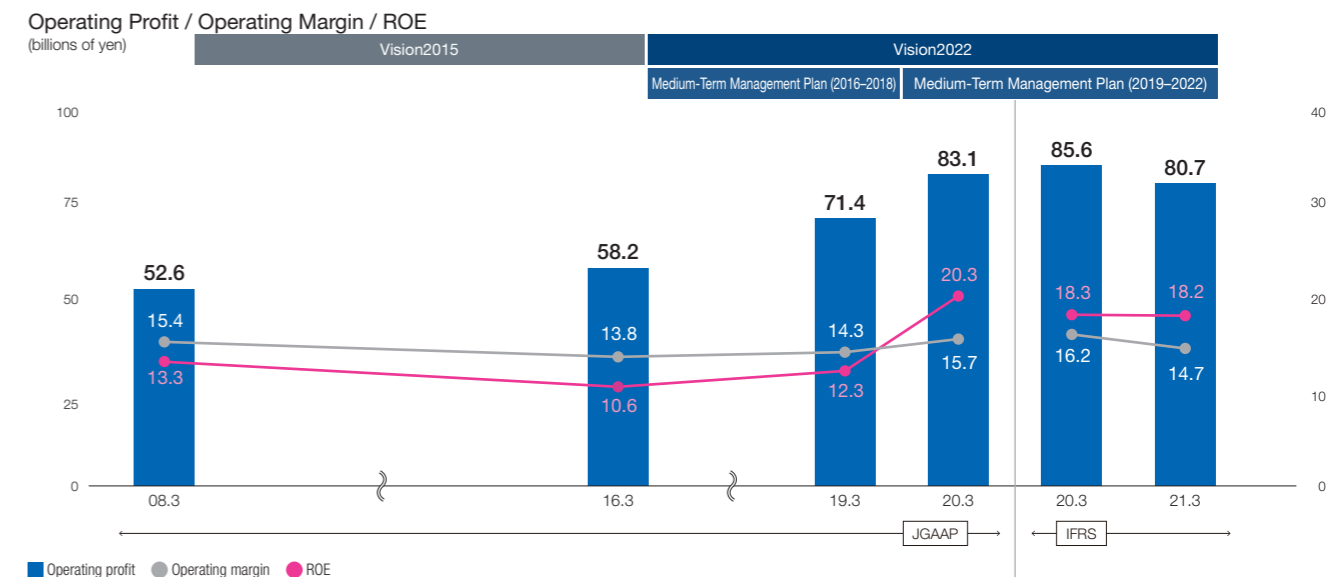
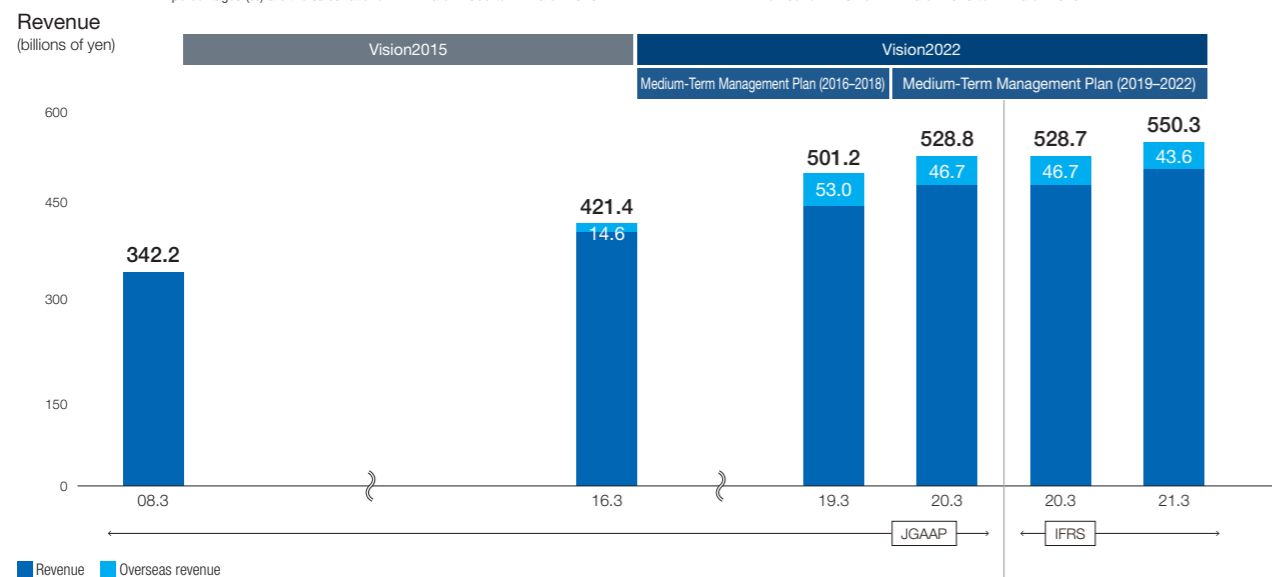

Vision2022 and Medium-Term Management Plan Overview and Progress Status

As we aim for the final goal of V2022, NRI is moving forward with the Medium-Term Management Plan (2019–2022), the four-year second half of V2022. In FY March 2021, the second year of the Plan, the growth strategy of the Medium-Term Management Plan progressed steadily, and we achieved a high level of performance.

Long-Term Management Vision “Vision2022”

In April 2015, NRI launched its long-term management vision “Vision2022” (V2022), the final year of which is FY March 2023. It was created to realize NRI’s corporate philosophy of “Dream up the future.” NRI is positioning itself as a corporation that boldly tackles truly meaningful innovation based on its commitment and strengths.

In order to create the ideal future society, NRI will achieve its goals by further refining the three strengths that we have cultivated thus far; namely, insight, the ability to achieve, and the ability to co-create, and by achieving our five growth strategies.

5 Pillars of Vision2022 Growth Strategy

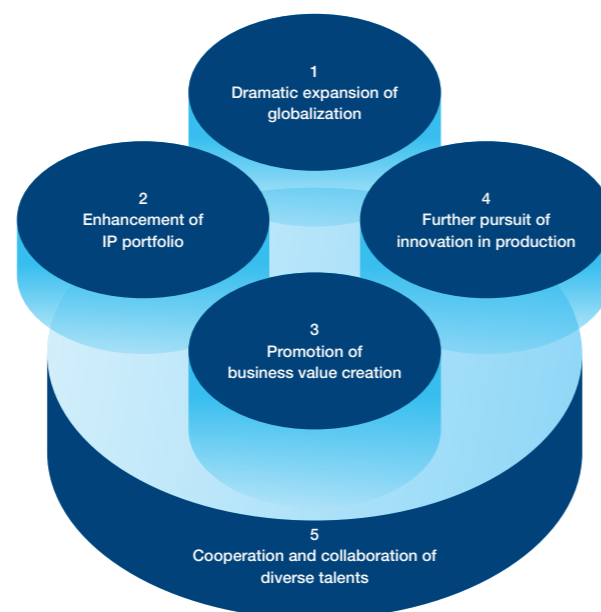

Vision Statement

We have imbued our thoughts for achieving V2022 into our vision statement “Share the Next Values!” With this in mind, each NRI employee is embracing the challenge of achieving new value.



Share	The diverse variety of personnel within the NRI Group joins together to pool their collective effort, and share the achievements and joy of contributing to a vibrant future society together with our clients.
Next	With the mentality of being ahead of the times we pioneer globally, digitally, and into the realm of the future , to create new business models for the next generation.
Values	We refine our strengths and create value by providing various types of services to clients and to society , giving birth to new future-minded business models.

NRI Sustainability Management Policy

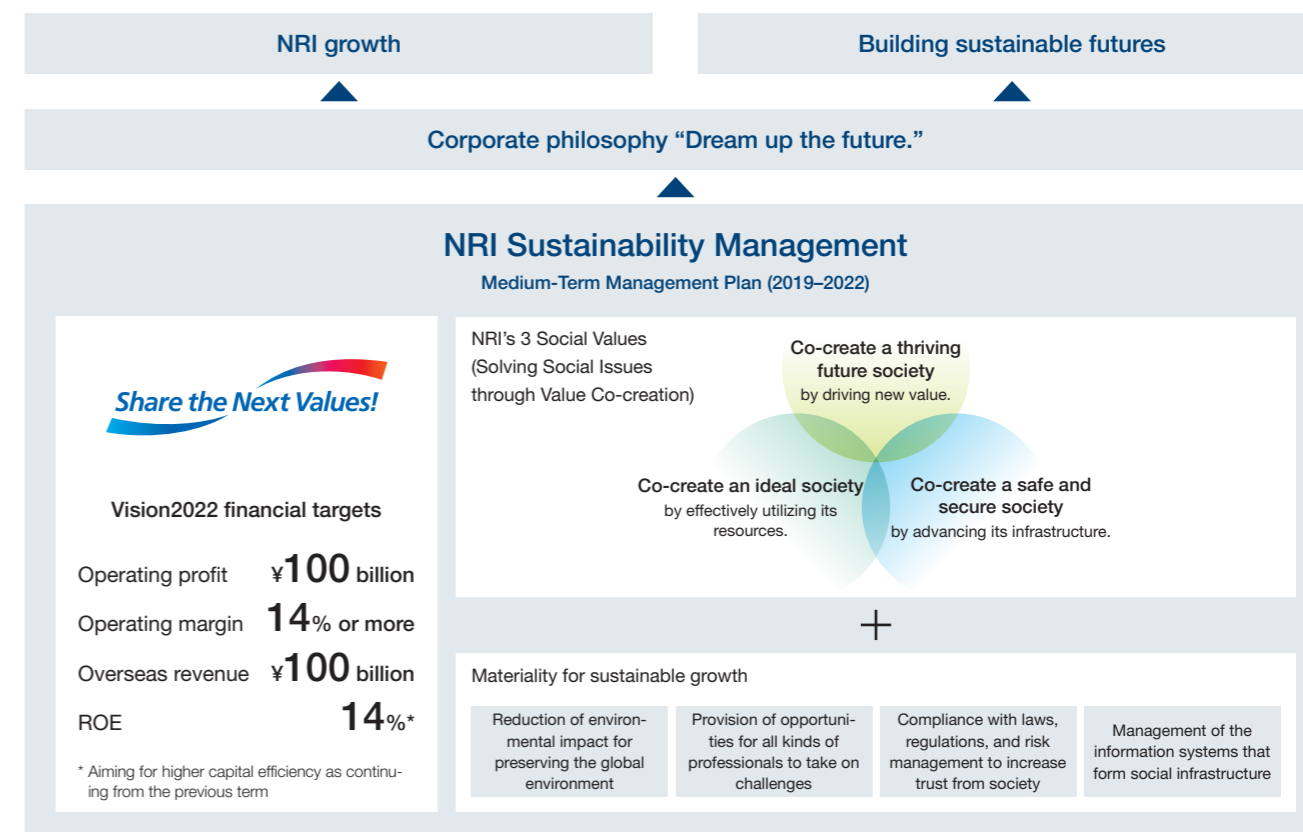

Medium-Term Management Plan (2019–2022)

The Medium-Term Management Plan (2016–2018) was launched in April 2016 as the first step toward achieving V2022. In FY March 2019 (the final fiscal year), we were able to achieve the originally planned goals of ¥500 billion in revenue and ¥70 billion in operating profit.

NRI launched the Medium-Term Management Plan (2019–2022), the four-year second half of V2022 that aims for the final goal of V2022, in April 2019. As the digital transformation of society speeds even faster ahead, NRI is moving forward with the three growth strategies of (1) DX Strategy, (2) Global Strategy, and (3) Human Resources Strategy, in order to achieve both resolution of the issues of our clients and society and the growth of NRI’s businesses.

Growth Strategy of Medium-Term Management Plan (2019–2022)

DX Strategy	Use technology to transform customer business models and processes
Business Platform Strategy	Evolve business platforms (BPFs) in finance
Cloud Strategy	Modernize legacy systems by using cloud infrastructure
Global Strategy	Achieve more global business growth, seeking revenue of ¥100 billion
Human Resources Strategy	Strategic recruiting, talent development

The Three Growth Strategies and Progress Status of the Medium-Term Management Plan

DX Strategy

In recent years, movement toward DX has heightened due to an increase in IT investment for business models and work process transformation utilizing digital technologies. Furthermore, corporations are accelerating the speed of change, triggered by rapid changes in the business environment caused by the spread of COVID-19. NRI realizes client transformation by leveraging its strength of combining consulting and IT solutions, and by utilizing technology to provide comprehensive support from strategy formulation to solution implementation.

NRI defines DX that contributes to business process transformation of existing businesses as "DX 1.0," and DX that uses digital technology to create a new business model itself as "DX 2.0." We are implementing initiatives for each type of DX. In the field of "DX 1.0," NRI is moving forward with many initiatives related to the streamlining of business and further sophistication of infrastructure, utilizing digital technology. The demand is high for infrastructure transformation of the launch of EC business and the accompanying distribution/inventory systems for clients in the distribution, manufacturing, and service industries, etc., in particular, and NRI is providing support for it. In the field of "DX 2.0," we establish joint ventures with clients and companies that have advanced technologies and promote the creation of new businesses utilizing digital technologies via collaboration. Also, NRI has newly defined DX that solves social issues and realizes a paradigm change as "DX 3.0."

Framework of NRI's DX Strategy

Social transformation	DX 3.0	Paradigm transformation	Resolve social issues through co-creation with various partners <ul style="list-style-type: none"> Revitalize local communities through digital and entrepreneur support Digital solutions to reduce carbon, save resources, etc. 	
	DX 2.0	Business model transformation	Establish innovative digital services <ul style="list-style-type: none"> Build new multi-industry platforms Create new business models and ecosystems for clients 	
Transformation of clients and industries	DX 1.0	Process transformation	Digital front office	Digitalize actions for end users <ul style="list-style-type: none"> D2C*, CRM, digital marketing
			Digital back office	Digitalize actions within client companies <ul style="list-style-type: none"> SCM reforms, AI & RPA, business platforms
	Infrastructure transformation	Enhance infrastructure such as cloud, security <ul style="list-style-type: none"> Support migration to cloud, managed services, security business 		

* D2C (Direct to Consumer): Selling directly to consumers through e-commerce, etc.

DX 2.0 (Business Model Transformation) Expanding via Co-Creation with Customers

<p>KDDI Digital Design Inc.</p> <p>Established with KDDI CORPORATION in 2017. Provides total support from drafting of corporate DX strategy to commercial verification and system development/operation.</p>	<p>Technium CO., LTD.</p> <p>Established with DMG MORI CO., LTD., in 2018. Leverages digital technologies to support high-level utilization of production equipment at plants, etc.</p>	<p>NDIAS, Ltd.</p> <p>Established by DENSO CORPORATION and NRI Secure in 2018. Provides security assessment and consulting services for onboard electronic devices for the automobile industry.</p>
<p>JAL Digital Experience Co., Ltd.</p> <p>Established with Japan Airlines Co., Ltd. (JAL), in 2019. Proposes personalized services for a rich experience and lifestyle during tourism and everyday life.</p>	<p>BOOSTRY Co., Ltd.</p> <p>Established with Nomura Holdings, Inc., in 2019. Develops and provides transaction platforms that use blockchain technology for issuing and distributing securities and other rights.</p>	<p>Financial Digital Solutions, Ltd.</p> <p>Established with QUICK Corp. in 2019. Uses the experience and know-how of both companies to develop efficient services for responding to changes in the environment surrounding financial institutions.</p>

Business Platform Strategy

We will aim to expand the clients and services by providing new services such as those for handling back-office work, while expanding the users of shared online services such as "THE STAR," a back-office solution for retail brokerage firms. For our clients who will be entering the financial services industry from other industries to meet transformations in the industry structure, we will provide new business platforms as support for customers to swiftly create new businesses and advance into new markets.

Initiatives for Business Platform Strategy

In addition to back-office platform services such as THE STAR, which we have provided up to now, NRI aims to create platform services in the front-office processes of financial institutions by reorganizing and expanding existing intellectual assets and constructing new mechanisms.

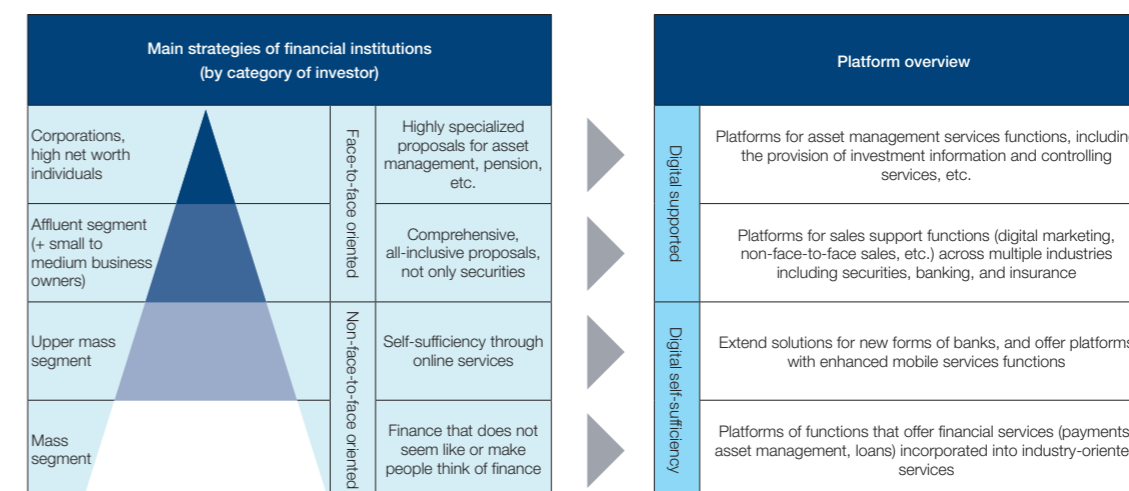

Cloud Strategy

Demand for overall system optimization is increasing due to the diversification and sophistication of customer system platforms, such as on-premise usage and utilization of multiple cloud platforms. In order to meet this demand, NRI provides multi-cloud services that enable the centralized management of multiple cloud platforms and managed services that comprehensively assist and optimize entire systems in lieu of customer IT departments.

Initiatives for Cloud Strategy

Using the World's First Oracle Dedicated Region Cloud

In March 2020, NRI announced that, as part of strengthening this service, it would be the first company in the world to adopt Oracle Corporation's "Oracle Dedicated Region Cloud" and use it as NRI's exclusive public cloud.

Utilizing useful services in the public cloud is an important factor for successfully realizing DX. NRI has established a dedicated public cloud in our own data center in order to maximize the usefulness and competitiveness of the public cloud, while at the same time responding to the need for safe and secure governance and security under our own control.

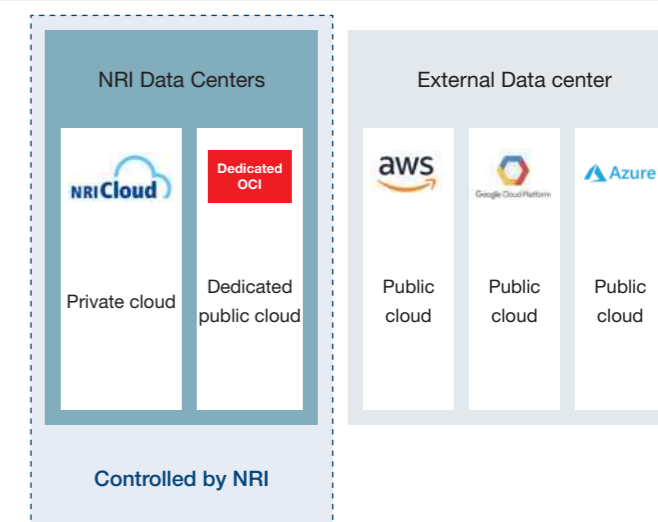

Global Strategy



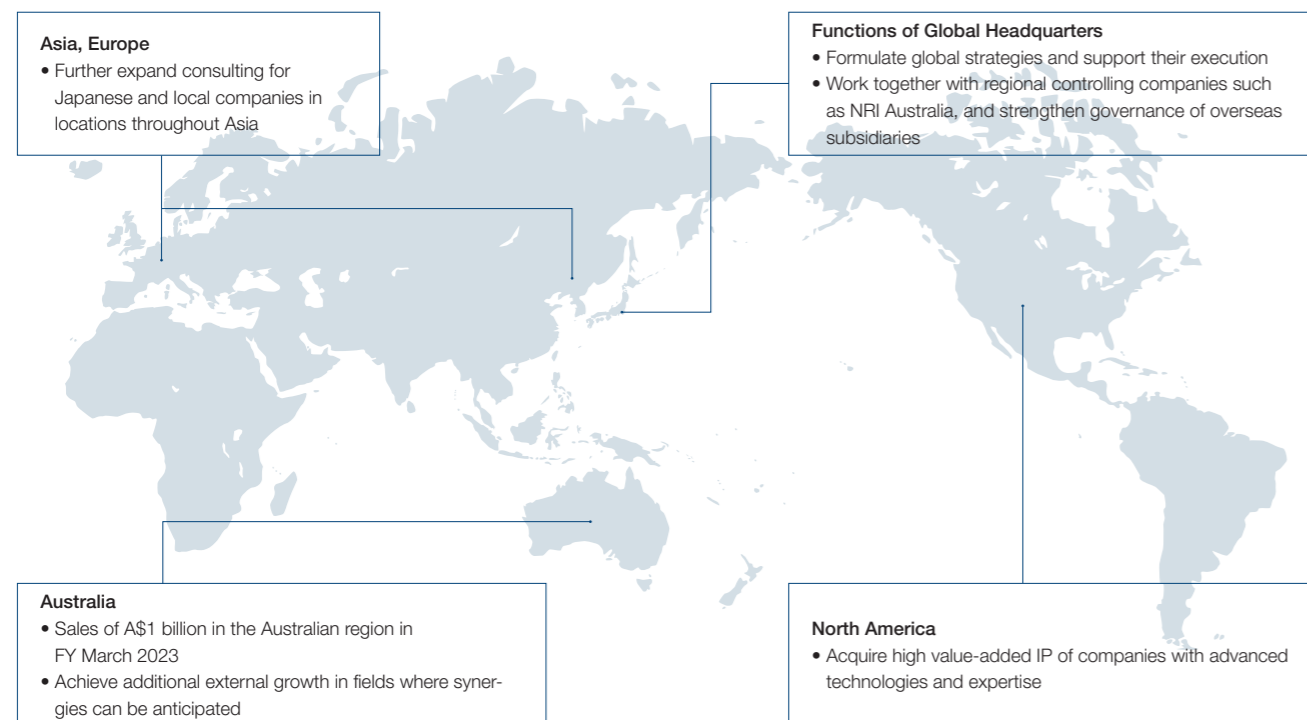

In order to achieve our target of ¥100 billion in overseas revenue as indicated in V2022 and our Medium-Term Management Plan (2019–2022), we are executing growth strategies for the three regions of Australia, North America, and Asia/Europe, and moving forward with the expansion of our global business base with external growth via M&A, etc.

In FY March 2021, business was sluggish due to the effects of COVID-19. However, in May 2021, we established two new subsidiaries in Australia. NRI will continue to pursue our global strategy centered on Australia. We aim to reach overseas sales of ¥100 billion in FY March 2023.

Global Strategy



Business Base Expanding Globally

Region	Company name	Company overview
Australia		ASG Group Limited (Acquired in 2016) Provides end-to-end services to enable clients to achieve digital transformation and innovation, from consulting to application, infrastructure, data, and security. The main clients are governmental agencies and major financial and telecommunications companies, etc.
		Planit (Acquired in 2021) A group specialists in IT testing headquartered in Sydney. More than 1,000 specialists in testing provide a wide range of services from consulting related to improving the quality of IT systems to support for executing test processes and provision of automated tools for testing. The largest IT testing corporation in the Oceania region.
		AUSIEX (Acquired in 2021) Providing high value-added IT services to major Australian financial institutions and IFAs through IT systems developed independently for back-office areas (securities transaction management, portfolio management, etc.) and standardized operations.
North America		Brierley+Partners, Inc. (Acquired in 2015) The founder was the person who designed and operated the first mileage program at a U.S. airline. "Brierley LoyaltyWare®," an integrated loyalty program solution, including all necessary functions, such as membership registration for customers, recording and tracking customers' action history, and acquiring points and mileage, as well as redeeming points.
		Cutter Associates Europe, Ltd. (Acquired in 2016) Cutter Associates has strength in research and consulting in the U.S. asset management industry and has the largest client base in the country, including over 200 firms such as asset management firms, insurance firms, and pension funds.

Initiatives of Expanding Our Business Base in Australia

In May 2021, we established two new subsidiaries: Planit, which is Australia's largest testing company, and AUSIEX, which is a group company of CBA Bank (Commonwealth Bank of Australia Limited), one of Australia's four largest banks.



Planit Test Management Solutions

- **Third highest revenue in the world** as IT testing specialists (first in Oceania region)
- Strength in testing for mission critical domains with abundant human resources and original IP

Established	1997
Locations	Australia (HQ: Sydney), New Zealand, India, UK
Business	IT testing, test automation, consulting, etc.
Employees	Approx. 1,300
Annual revenue	A\$151 million (FY ended June 2020)

AUSIEX

Australian Investment Exchange

- **Among the top** in Australia's finance back-office services industry
- Providing high value-added services through in-house developed systems and standardized operations

Established	1996
Locations	Australia (Sydney, Perth)
Business	Financial institutions, back-office services for independent financial advisors (IFAs)
Employees	Approx. 250
Annual revenue	A\$62 million (FY ended June 2019)

NRI Australia Expansion Strategy

ASG was acquired in 2016. As a key player that leads the IT market in Australia, ASG has expanded its business platform by providing long-term managed services, mainly to governmental agencies. Moving forward, in addition to organic growth, NRI will seek to expand our industry and services in Australia through M&A. AUSIEX, which was established as a new subsidiary, will seek to incorporate technologies related to shared online services provided in Japan and build a business platform that covers areas other than wealth management, an area in which AUSIEX has traditionally excelled. NRI also plans to further expand the business of the newly acquired Planit by expanding our provided services and expanding the region.

NRI Australia oversees the Australian region. Similar to our operations in Japan, the company aims to evolve into a corporate entity that possesses services for heightening system quality in addition to strengths in consulting, operational services, and BPO.

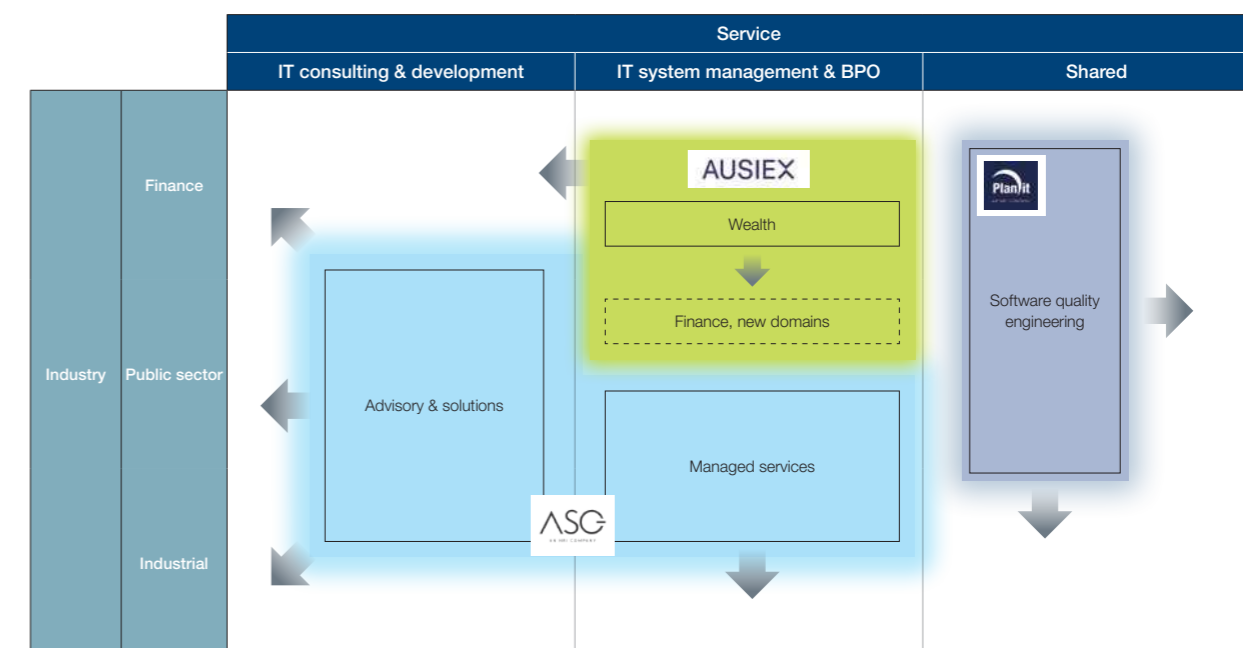

Human Resources Strategy

In order to execute the DX strategy and global strategy of the Medium-Term Management Plan (2019–2022), we must secure human resources that can solidly advance these strategies. Therefore, NRI is strengthening new graduate and mid-career hiring, and developing employees. In terms of development, we are enhancing training programs for human resources who want to acquire skills needed for advancing DX projects or for converting their skills.

Moreover, we are fostering an organizational culture that makes it possible for employees to play an active role and take on challenges, promoting diversity, and moving forward with NRI-like work-style reform. We are also strengthening relationships by collaborating with business partners that possess expertise in digital technology and know-how.

Human Resources Strategy

Bolster hiring	<ul style="list-style-type: none"> • Increase of 1,000 staff or more (at NRI alone) over four years • Bolster new graduate hiring: Bolster promotions, etc. • Bolster mid-career hiring: Further improve systems of working conditions for the hiring of more specialists, etc. 									
	<table border="1"> <thead> <tr> <th></th> <th>FY March 2019</th> <th>FY March 2023 (Plan)</th> </tr> </thead> <tbody> <tr> <td>New graduate hires</td> <td>319 persons</td> <td>Stable expansion</td> </tr> <tr> <td>Mid-career hires</td> <td>133 persons</td> <td>Double</td> </tr> </tbody> </table>		FY March 2019	FY March 2023 (Plan)	New graduate hires	319 persons	Stable expansion	Mid-career hires	133 persons	Double
		FY March 2019	FY March 2023 (Plan)							
New graduate hires	319 persons	Stable expansion								
Mid-career hires	133 persons	Double								
Promote employee skills transfer and development	<ul style="list-style-type: none"> • Strategically develop business designers, data scientists, and other such personnel • Skills transfer and development for application/platform personnel to support DX strategy 									
Promote employee success	<ul style="list-style-type: none"> • Promote diverse work styles (diversity, participation, and advancement of women and senior personnel, etc.) 									
More development partners	<ul style="list-style-type: none"> • Get more development partners that have technologies and expertise in areas such as DX 									

Initiatives for Human Resources Strategy

• Bolster hiring

Hiring activities were conducted online in FY March 2021. NRI is steadily expanding the hiring of new graduates in accordance with the hiring plan set forth in the Human Resources Strategy. NRI is also steadily hiring mid-career hires and enhancing support for achieving their goals; for example, vitalizing promotion activities.

• Promote employee skills transfer and development

In accordance with the concept of “+DX” that adds the essence of surviving the DX era instead of discarding skills that have been cultivated thus far, NRI has held more than 100 human resources programs for developing skills ranging from technical skills to human skills and DX skills. NRI held online training programs in FY March 2021. The number of employees participating in training increased by 1.5 times compared with the previous year, and many employees are working to convert and improve their skills.

Number of New Hires (Persons)

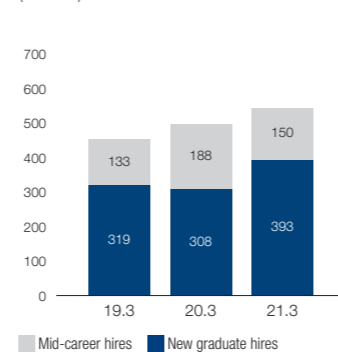

Embracing the Challenge of Solving Social Issues

Until now, NRI has implemented DX 1.0 for achieving process transformation and infrastructure transformation, and DX 2.0 for realizing business model transformation. Through these strategies, NRI has achieved the transformation of clients and the industry. Awareness of social issues has increased in recent years, and corporations are expected to solve such issues. NRI believes that digital technology can be used to solve social issues. We will take on the challenge of social transformation through DX 3.0, which aims to solve social issues through co-creation with various partners.

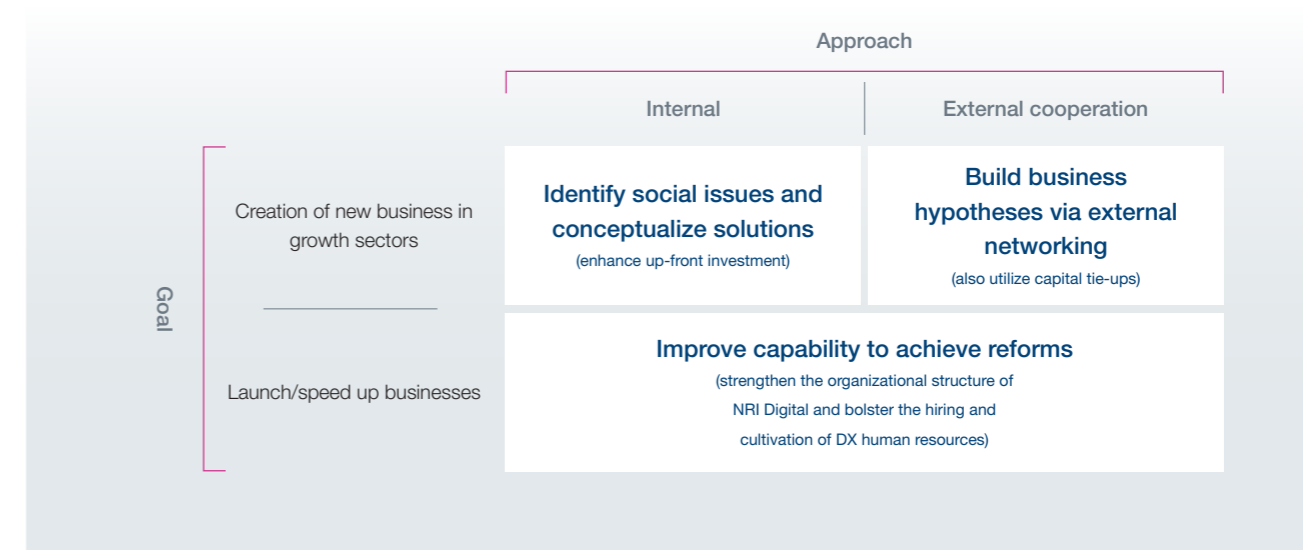

NRI will promote DX 3.0 by strengthening and accelerating our unique business model “Con-Solution” based on NRI’s strengths in consulting and IT solutions. In particular, we will explore business opportunities for carbon neutral, circular economy, and food value chain, which are areas that have been attracting attention in recent years.

Example of initiative themes

Carbon neutrality



- Visualization/central management, etc., of CO₂ emissions in business activities and products/services

Circular economy



- Save resources by tracing product usage information and resource utilization after product use, etc.

Food value chain



- Digital infrastructure for producers and common platforms for ordering and distribution, etc.

Promote DX 3.0 to create a sustainable future society

Finance Strategy Message from the Head of Finance

We will practice even more robust and aggressive financial management against the background of high cash flow generation ability.

Yoshihiko Sunaga
Senior Corporate Managing Director
Head of Finance



In FY March 2021, net sales and operating profit grew steadily based on the powerful cash flow generation ability that leveraged NRI's strengths even during the spread of COVID-19. At the same time, in addition to voluntary application of International Financial Reporting Standards (IFRS) and other efforts for responding to globalization, NRI has largely achieved the goals of the financial indicators that we emphasized, and have implemented stable financial management that supports growth.

In FY March 2022, as we move toward the completion of V2022, we will consider an appropriate balance for maintenance of existing businesses, growth investment, and shareholder returns based on our existing policies. At the same time, we will enhance the following three points in order to further increase corporate value: (1) aggregation/sale of offices and reform of the pension system in conjunction with changes/reform of work styles, (2) active investment in new business opportunities, and (3) improvement of capital efficiency and return to shareholders.

Major Strengthening Points in FY March 2022 (Example of Important Financial Indicators)

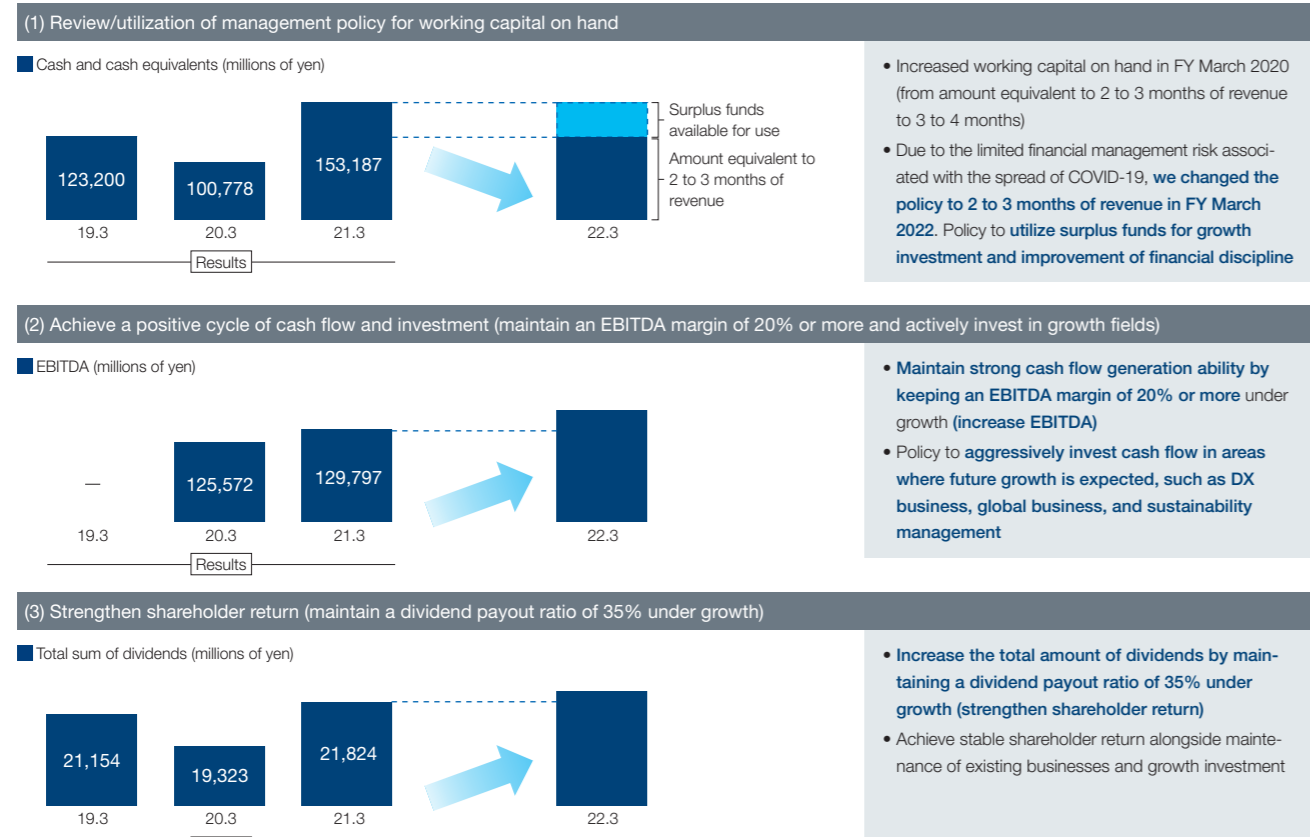

* All figures are from IFRS. The total amount of dividends listed above includes dividends earmarked for the NRI Group Employee Stock Ownership Group.

Aggregation/Sale of Offices and Reform of the Pension System in Conjunction with Changes/Reform of Work Styles

In addition to the diversification of people's values, the spread of COVID-19 is significantly changing our values regarding work styles. In response to this transformation and diversification of people's values, in addition to more appropriate reform of systems, NRI has reviewed and organized assets to strengthen our financial base. Specifically, NRI has introduced a hot-desking system and promoted working from home with an office attendance ratio of about 50%. We also sold an office building in Yokohama City and actively worked to aggregate offices. Under our general policy of not holding office assets in principle, we will continue to further aggregate and sell offices in conjunction with work-style reforms.

Furthermore, NRI has revised its retirement benefit plan in response to people's changing values regarding work styles. In addition to increasing options for pension contribution methods that employees can select according to their work style, this also makes it possible to significantly reduce future contributions for pension financing.

In FY March 2021, due to the spread of COVID-19, we temporarily increased our working capital on hand in preparation for unforeseen circumstances. However, as a result of monitoring and analyzing the movement of funds over the past year, we confirmed that the anticipated risk is limited. Therefore, in FY March 2022, we plan to secure an amount of working capital on hand equivalent to two to three months of revenue and operate our business. NRI will continue to work to strengthen our financial base by carefully gaining insight into social trends and changes in people's values.

Active Investment in New Business Opportunities

Based on our corporate philosophy of "Dream up the future," NRI has shown our commitment to creating a brighter future through innovation and to contributing to the

resolution of social issues. By utilizing the powerful cash flow generation ability that did not decline even during the COVID-19 pandemic, and based on value provided to society as defined by NRI, we will actively invest in new business opportunities in order to strengthen both financial capital and non-financial capital such as intellectual capital, social/relationship capital, and nature capital.

Specifically, in FY March 2022, we will continue to maintain an EBITDA margin of 20% or higher and aggressively invest in DX business including carbon neutral and other DX 3.0 themes, such as global business, sustainability management, etc. By doing so, we will contribute to the resolution of social issues while stimulating a positive cycle of cash flows and investment.

At the same time, the net D/E ratio for bonds payable and loans will support further growth under appropriate financial discipline, up to a maximum of 0.3 times the conventional standard.

Improving Capital Efficiency and Shareholder Returns

NRI has traditionally conducted financial management while consciously maintaining an ROE of 20%. We announced the acquisition of treasury stock in June 2021. Going forward, we will continue to conduct financial management while consciously maintaining an ROE of around 20%, which is equivalent to the level of capital efficiency in Europe and the United States.

At the same time, NRI will continue to provide stable shareholder return with the goal of a dividend payout ratio of 35%, which has always been our policy. We will also continue to consider the acquisition and retirement of treasury stock to enable flexible capital policies that respond to changes in the management environment.

By enhancing the three points discussed above, NRI will practice robust and active financial management so that we can co-create with clients, shareholders, and society, and further improve our corporate value.

Balance Sheet Management Policy

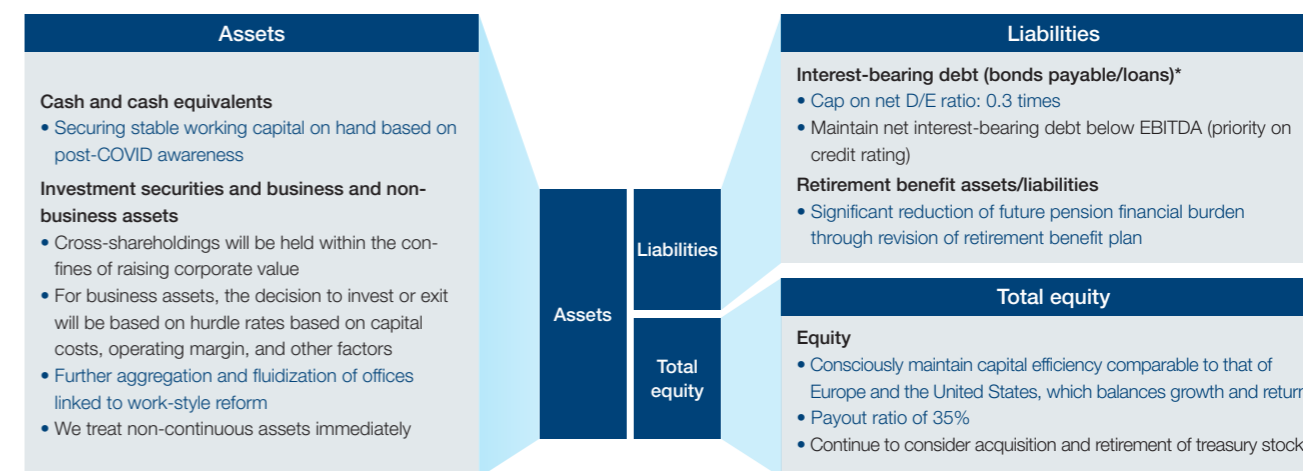

Blue: Areas prioritized for enhancement for FY March 2022

* Interest-bearing debt refers to bonds payable and loans from among liabilities recorded on the consolidated financial statements.

NRI Sustainability Management Policy

Under V2022, we are moving forward with NRI Sustainability Management that enables both NRI's continued growth and the building of a sustainable future.

The "Dream Up the Future" Corporate Philosophy and Sustainability Management Policy

To achieve sustainable growth, it is indispensable that a company creates both social and economic value, and carries out management from a long-term perspective. The prospectus that was created at the time of NRI's founding states that the aim of establishing the company was "to promote industry and be of service to society." In other words, resolving social issues through our business is natural for NRI, and is itself our DNA. The "Dream up the future" corporate philosophy – advocated by NRI since around the time of founding – encapsulates the Company's commitment to contributing to the resolution of social issues and creating a better tomorrow through the power of innovation.

NRI has identified material issues (materiality) for sustainable growth and defines solutions to social issues through co-creation of value in business as "NRI's 3 Social Values." NRI aims for sustained growth and to create a sustainable future society by implementing sustainability management that increases corporate value from the perspective of economic value as well as the perspective of social value.

NRI Sustainability Management Policy

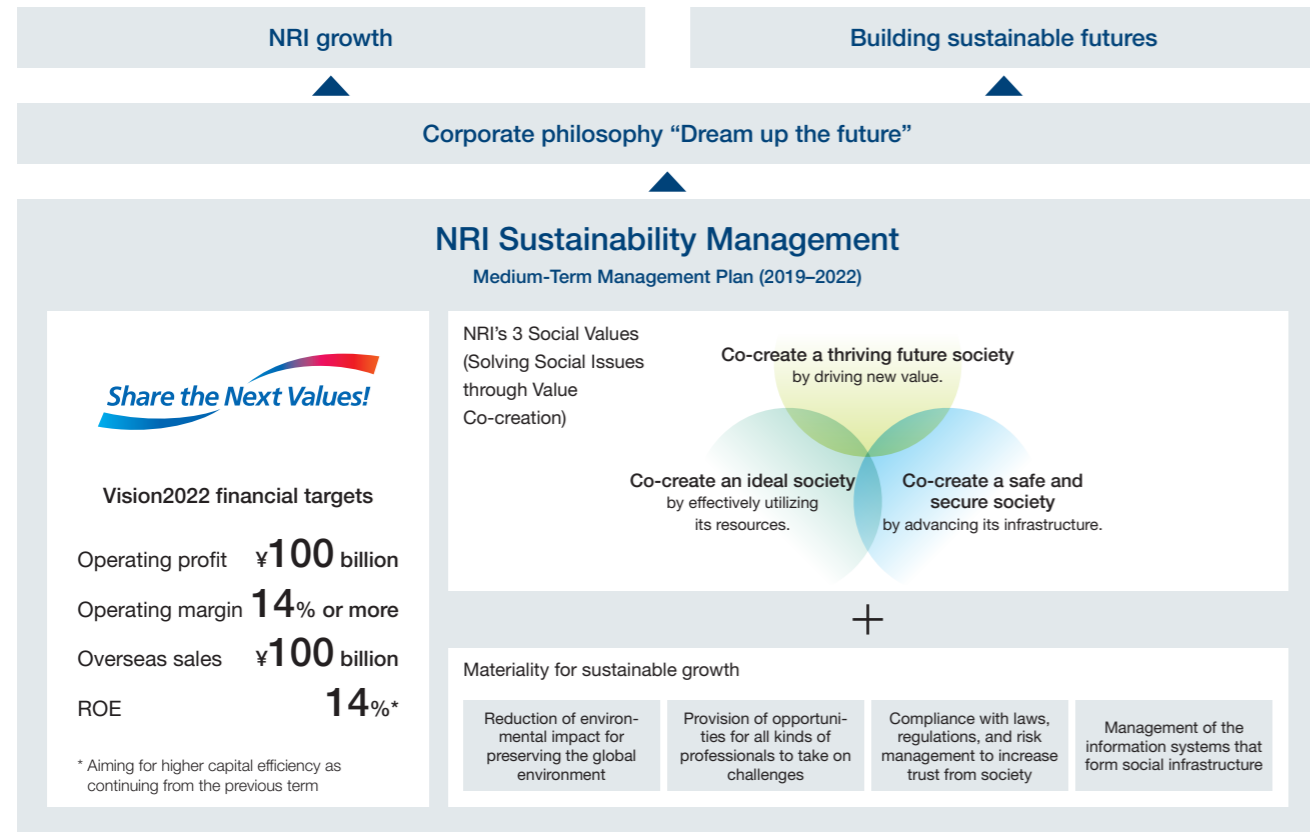

Sustainability Management Structure

NRI established the Social Value Creation Committee and the Sustainability Activities Committee as a special appointment at the direction of the President & CEO to promote overall sustainability management. Both committees make proposals to the Senior Management Committee and others.

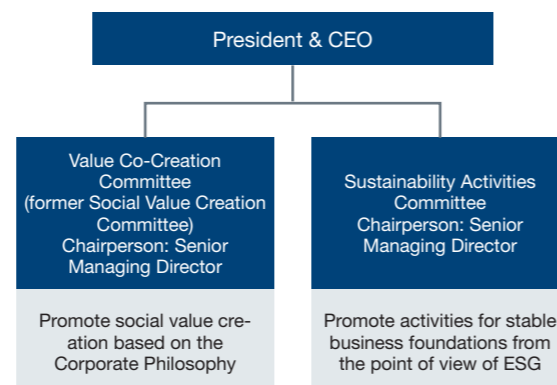

Monitoring the Status of Efforts for Co-Creation

NRI's 3 Social Values that were formulated in the Medium-Term Management Plan are incorporated into the business plan each year and implemented in each business. The status of efforts is reported to, and monitored by, the Board of Directors each quarter and the results are reflected again in the plan. We are promoting sustainability management by implementing this PDCA continuously throughout the company.

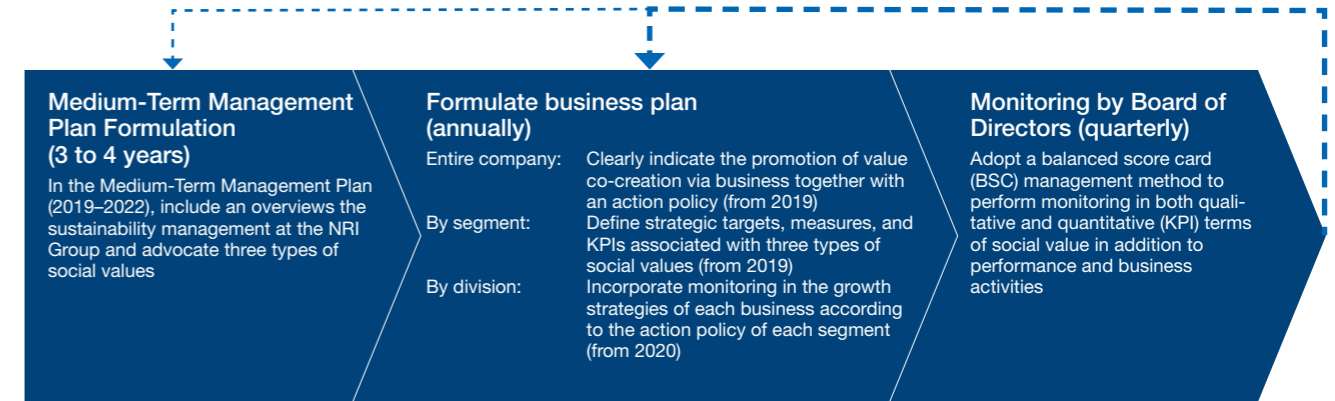

NRI's 3 Social Values and the Process for Identifying Material Issues

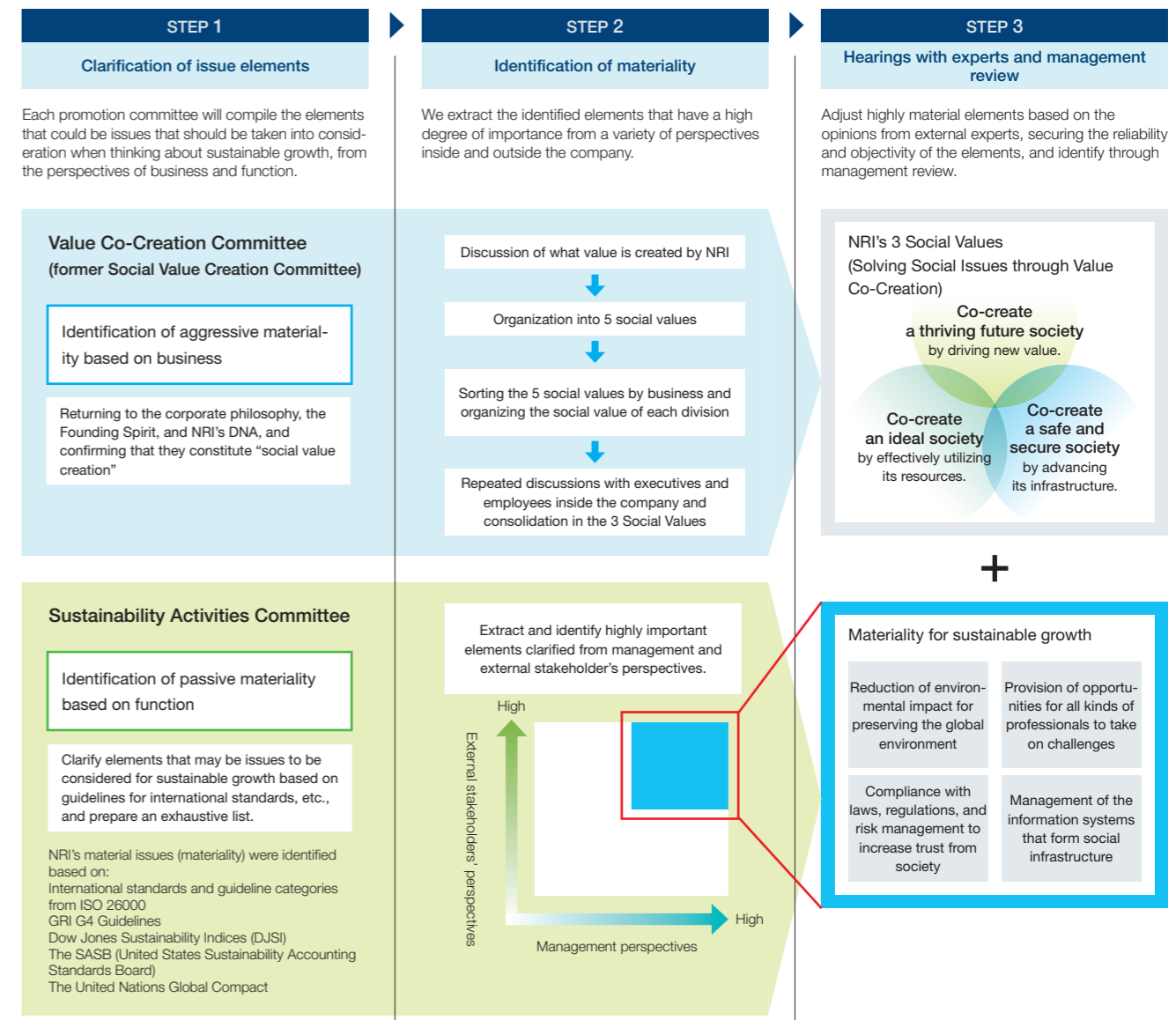

NRI's 3 Social Values (Solving Social Issues through Value Co-Creation)

Social value created in efforts to solve problems through all NRI businesses have been defined as NRI's 3 Social Values, with the aim of resolving social issues through value co-creation. We contribute to creating a sustainable future society through co-creation of the 3 Social Values.

Co-create a thriving future society
by driving new value.



The continuous generation of new values for the future and the creation of an affluent and comfortable society in which all consumers can enjoy those values.

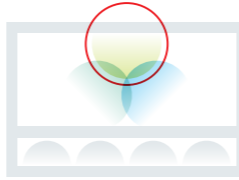

NRI is promoting digital transformation (DX) in different ways: DX 1.0, in which we upgrade clients' legacy business processes, and DX 2.0, where we work with clients to create new businesses, in many cases launching joint ventures with those clients.

Medium- to long-term measures	FY March 2021	
	Status	KPI
Promote DX	Working on large numbers of DX projects including for non-face-to-face, remote, e-commerce. Leading the digital transformation of companies	DX-related sales: ¥329.3 billion
Create new business models	Collaborating with outside companies to create AI analysis systems, new DX consulting services, etc.	Number of affiliations (joint ventures, government support, etc.): 4
Provide social recommendations and system proposals	Recommendations for how post-COVID-19 society should be, including employment policy based on estimated real unemployment	Number NRI articles featured in the big five national newspapers: 121

Example of Co-Creation

Communication of Recommendations for Society that are Unique to NRI

At NRI, diverse professionals with high-level expertise are constantly analyzing changes in the environment, and conducting activities to predict future changes and provide social recommendations. The recent spread of COVID-19 is anticipated to result in environmental change that could significantly alter the future society due to the size of its impact. Accordingly, we are actively providing recommendations related to a variety of social issues and the ideal nature of post-COVID-19 society.

Proposals regarding Coronavirus Infection (COVID-19) measures

We posted on the website and otherwise communicated recommendations for society from a variety of perspectives, such as changes in behavior caused by the spread of COVID-19 and the ideal nature of post-COVID-19 corporate management.



Proposals regarding Coronavirus Infection (COVID-19) measures
<https://www.nri.com/en/keyword/proposal>

The "Substantial Unemployment" and "Isolation from Assistance" of Women That are Sharply Increasing during the COVID-19 Pandemic → P.95

Apart from the statistics indicating a decrease in the number of female non-regular employees and part-timers caused by the COVID-19 pandemic, it has been hypothesized that there are a large number of substantially unemployed people. NRI conducted its own survey analysis on the matter.

It caused a significant impact, including being cited in more than 200 articles in newspapers and other publications.



Shinichiro Umeya
Center for Strategic Management & Innovation



Kana Takeda
Center for Strategic Management & Innovation

Co-create an ideal society
by effectively utilizing its resources.



Nurture strong industries that effectively utilize valuable social resources (manpower, goods, capital, and intellectual property) and aim to create a comfortable society for everyone.

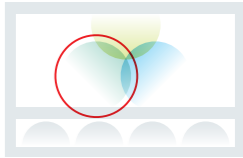

NRI has contributed to reforming the business processes of financial institutions by developing shared-use platforms that support finance, such as THE STAR and BESTWAY, and also bringing about a reduction in CO₂ emissions through cloud-based joint use of information systems. Going forward, we will continue to create new platforms for new fields and new customers, and promote businesses that co-create a business foundation that ensures effective utilization of corporate social resources.

Medium- to long-term measures	FY March 2021	
	Status	KPI
Expand services in business platforms	Deployment of shared online services, including THE STAR implementations at large clients	Business platform sales: ¥102.9 billion
Generate environmental benefits for clients through business platforms	Selected for inclusion in the DJSI World stock index for 3 consecutive years, and recognized as a CDP A List company for 2 consecutive years	Clients' reduced CO ₂ emissions due to shared use: 81,832 tons
Help build IT infrastructure to create an ideal society	Collaborating with Oracle on advancing IT infrastructure by expanding use of the public cloud	Size of cloud and data center services business: +5% , compared to FY March 2020
Facilitate transformation for societal optimization	Working on operational reform projects including logistics and transport optimization leveraging data science	Size of business regarding operational reform-related services: +17% , compared to FY March 2020

Example of Co-Creation

Supporting Reduction of Clients' Greenhouse Gas (CO₂) Emissions through the Use of Shared Online Services

Shared online services, one of NRI's main businesses, enable customers to share use of systems that operate in NRI's data centers. It makes it possible to keep electric power consumption below what it would be if the client built and operated the system on its own, and leads to a reduction of greenhouse gas emissions. NRI provides shared online services such as THE STAR and BESTWAY in a variety of areas.

Shared use of the data centers resulted in a 81,832 ton reduction of clients' CO₂ emissions.*

NRI estimates that it is possible to reduce clients' greenhouse gas emissions by 73.9% through the use of shared online services.

* Reduction of clients' CO₂ emissions: The difference between the estimated amount of CO₂ emissions if the client were not to use shared online services and the actual estimated emissions (when using shared online services in that fiscal year)

CO₂ reduction effects via shared online services

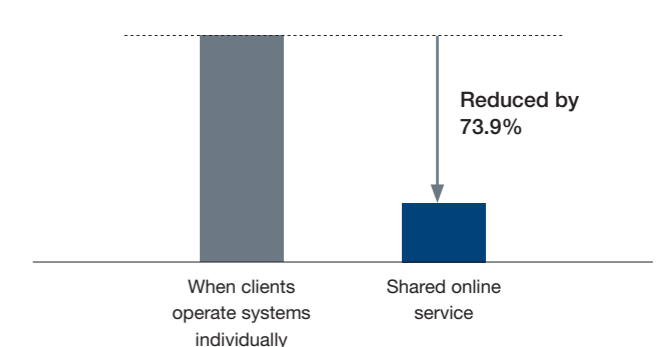

Major shared online services



Co-create a safe and secure society by advancing its infrastructure.



Protect social infrastructures such as information systems and aim to create a safe and secure society that can easily withstand accidents and disasters.

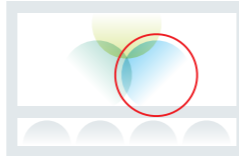

As information systems become more complex, NRI is engaged in business providing security and other managed services. We have also been involved in activities related to disaster prevention and mitigation, and reconstruction support.

Medium- to long-term measures	FY March 2021	
	Status	KPI
Help upgrade the social infrastructure	E-filing year-end tax adjustments using Mynaportal, and expansion of e-NINSHO identity verification	Size of business involving public sector: +22% year-on-year
Contribute to information security	Bolstering our Zero Trust business structure and supporting better security in the cloud era	Amount of investment in safety and security: ¥6.5 billion
Maintain the quality of systems in operation	Conducting and maintaining training for operations during large-scale failures at data centers in remote environments	Number of information systems failures causing significant financial and social impact: No occurrences

Example of Co-Creation

Digitalization of Tax Returns through the Use of Mynaportal and Expansion of the e-NINSHO Public Identity Verification Service

NRI is engaged in the development of services that cross the boundaries between the public and private sectors and creation of usage scenarios to spread and entrench the My Number Card, which is increasingly taking hold, as a “digital society ID.”

The e-NINSHO identity verification service that uses the My Number Card is being widely used in the public and private sectors for things such as opening brokerage accounts, collecting My Numbers from employees, and identity verification when submitting applications, etc., to local municipalities (Yahoo! Kurashi), and has the most extensive track record in the public sector.

Further, in the fiscal year ended March 2021, we constructed a mechanism that made it possible to receive each type of notification from insurance companies and securities companies and file tax returns via the government-operated

Mynaportal, in preparation for the digitalization of tax return filing, a priority theme in digital government policy. We will continue expanding the targets of digitalization in the future, including *furusato nozei* (“hometown tax”).

NRI will contribute to the promotion of use of the My Number Card and the improvement of convenience, and promote and achieve the digital transformation of society, by addressing digitalization from the perspective of users.



Materiality for Sustainable Growth

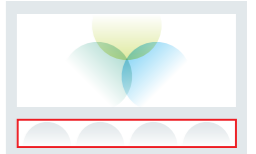

The continued growth of NRI is crucial to the promotion of resolution of social issues through growth strategy and value co-creation. NRI has identified issues that should be considered when working to achieve sustained growth, then combined them in four key issues for sustainable growth, and we are working toward resolving the issues.

	Policies	Status	Page No.	
	KPI			
<p>Reduction of environmental impact for preserving the global environment</p>	<ul style="list-style-type: none"> Response to climate change Sustainable energy consumption Responsibility and conservation to the environment Environment-conscious supply chain 	<ul style="list-style-type: none"> Set a New Environmental Target Implemented and expanded the scope of NRI-EMS, a unique environmental management system for offices at NRI Relocated to office buildings with superior environmental performance; used renewable energy Acquired SBT Initiative certification for greenhouse gas reduction targets formulated by NRI Joined RE100, an initiative by corporations seeking to transition to 100% renewable energy for power used in business activities Initiatives pertaining to Final Recommendations of the Task Force on Climate-related Financial Disclosures (TCFD) Selected for the CDP's highest rating, the Climate Change A List for the second year in row Providing ESG training for employees 	Natural Capital P.72-79	
<p>Provision of opportunities for all kinds of professionals to take on challenges</p>	<ul style="list-style-type: none"> Human resource diversity Healthy employment and labor management relationship Respect of human rights 	<ul style="list-style-type: none"> Human resources development initiatives including DX human resources development programs Hosting of the Work Motivation Co-Creation Forum Formulating the NRI Group Human Rights Policy and NRI Group AI Ethics Guidelines, Publishing the NRI Group Human Rights Report Expanded actions to support the balance of work and child-rearing by male employees In June 2017, opened the in-office nursery Yumeminato Hoikuen Based on the “Act on Employment Promotion, etc. of Persons with Disabilities,” promoted the hiring of persons with disabilities by our special subsidiary NRI Mirai Developed a new office environment that promotes work-style reform and internal/external interactions 	<p>Ratio of female managers 7.6%</p> <p>Ratio of female hires 27.2%</p>	Human Capital P.58-64
<p>Compliance with laws, regulations, and risk management to increase trust from society</p>	<ul style="list-style-type: none"> Enhancement of corporate governance Risk management Action against corrupt practices abroad Appropriate information disclosure to customers 	<ul style="list-style-type: none"> Established the Nomination Committee, which is mainly composed of independent directors Changed the main members composing the Compensation Committee from external experts to independent Members of the Board Implemented the restricted stock compensation plan as a medium- to long-term incentive compensation plan for Members of the Board Held the Sustainability Dialogue in order to discuss CSR with business partners Held ESG briefing and business information sessions for institutional investors and analysts Evaluating efforts for value co-creation at the division level, and adding it to their bonuses Established the Global Headquarters for global governance 	Social and Relationship Capital P.65-67 Governance P.80-91	
<p>Management of the information systems that form social infrastructure</p>	<ul style="list-style-type: none"> Management of information security and system Access to information society 	<ul style="list-style-type: none"> Enhanced project monitoring functions and held other activities to improve the quality of information systems Held the DX Production Innovation Forum and took other activities to improve company-wide quality and productivity Held the Safety and Security Forum and acquired certification/guarantees from third-party organizations Increased the level of information security measures both inside and outside Japan Increased the sophistication of our Computer Security Incident Response Team (CSIRT) in order to respond to cyberattacks 	Information systems failures that have serious financial or societal impact No occurrences	Manufacturing Capital P.68-71

Special Report

Awareness building activities for Value Co-Creation

For NRI to continue growing in the future as well, it is important to continue being “an indispensable presence in the world” that conducts business that contributes to the resolution of social issues. What can we do toward achieving a sustainable future society? Each employee continues to pose that question to himself/herself.

Instilling Value Co-Creation

NRI conducts a variety of activities, centering on the Social Value Creation Promotion Committee, to enable each employee to think about what value co-creation is, and consider ways to take on the issues faced by our clients and society overall, and overcome them. We have defined the processes for instilling organizations and employees with the concept of value co-creation as Recognition, Sympathy, Practice, and Establishment, and we are implementing a variety of measures suited to each process.

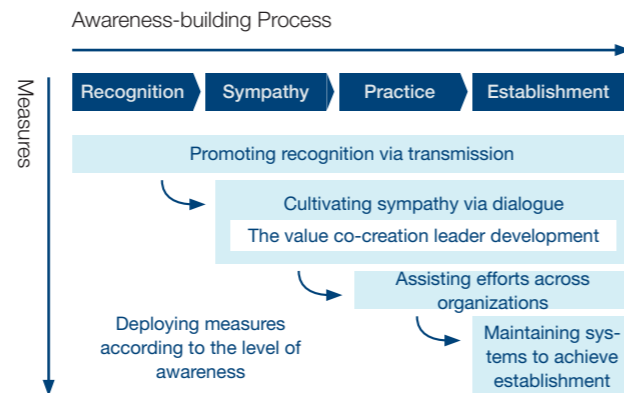

The Value Co-Creation Leader Development

Value co-creation leaders are the “successors” who continue spearheading reform through implementation of value co-creation. The value co-creation leaders gathered from each organization think about their own value co-creation and that of NRI and build a network that crosses boundaries between organizations, through a two-year development program. Further, they engage in implementation of value co-creation through dialogue with the president and members of management.

To date, 61 individuals have completed the value co-creation leader development program that was launched in the fiscal year ended March 2020, and value co-creation leaders are being born in each organization every year. After completing the program, value co-creation leaders do not merely implement value co-creation but they also promote activities to instill their own organizations with the value co-creation concept.



Dialogue with the president

The Value Co-Creation Leader Development Program

STEP 0 Realization	Realization as a successor
STEP 1 Knowing oneself	Rediscovering and recreating your own value standards
STEP 2 Knowing NRI	Rediscovering and recognizing the value standards of NRI
STEP 3 Knowing the client/society	Understanding the circumstances of the client and society and identifying issues
	Presentation to managers of value co-creation activities/dialogue with the president
Practical succession	Implementing value co-creation (1) Dialogue with young employees/managements
	Implementing value co-creation (2) Value co-creation day

The Views of Value Co-Creation Leaders

Through the development program, we were able to deepen understanding of the corporate philosophy to which we needed to return. Discussions with the president and members of management in the development program were helpful in regarding value co-creation as my own issue, and I have a strong feeling that I grew significantly myself. As a value co-creation leader, in the future, I want to work on implementing value co-creation in business myself rather than merely promoting efforts to entrench it in the organization.



Kaori Yamamoto
Cloud Computing Service & Planning Department

Kengo Sohara
IT Consulting of Financial-Sector Department

Natsumi Kashimoto
NRI System Techno, Ltd.

Promoting Recognition via Transmission

We are communicating a variety of information both inside and outside the company to spread recognition of value co-creation.

Sharing information on a special internal website

We launched an exclusive value co-creation website and are providing information on the thoughts of management, the views of clients, and efforts inside the organization.

Transmit information outside the company

In addition to providing information about NRI's value co-creation activities on the website, we introduce our efforts at the ESG Briefings that are held each year.

NRI's Value Co-Creation
https://www.nri.com/en/co_creation



Special internal value co-creation website

Cultivating Sympathy via Dialogue

We regularly establish opportunities, such as Co-Creation Day, for value co-creation leaders to report on activities and for members of management to engage in dialogue with employees, and to cultivate sympathy for value co-creation. Further, we conduct a variety of other activities aimed at helping everyone in the company think of value co-creation as their own issue, such as having value co-creation leaders take the lead in thinking about value co-creation in their own organizations and planning opportunities for dialogue.



A panel discussion on Value Co-Creation Day

Assisting Efforts Across Organizations

We support cross-organizational efforts from the implementation stage to the establishment stage. We aim to develop these activities into cross-organizational efforts by establishing opportunities for the sharing of past cases and discussion between organizations that are facing similar issues and concerns. In the fiscal year ended March 2020, we also began worksite-initiated efforts to think about social issues, not only across departments inside the company but also with stakeholders outside the company, and find ways for the overall industry to achieve sustained growth.

Worksite-initiated Efforts to Co-Create Value Across Multiple Organizations

Each year since 2019, NRI has planned and hosted the Next-generation Leader Exchange Session as a forum for young leaders in client companies and industrial associations that will lead the future of the securities industry and NRI employees to think about the social issues surrounding the industry. The third occasion of the event in October 2020 had 31 participants from throughout Japan, who discussed the ideal nature of securities sales during the COVID-19 pandemic, and exchanged views and ideas, on the theme “Considering Securities Sales to Survive the New Normal Era.”



A scene from the Next-generation Leader Exchange Session

Participants' Voices



Ruriko Hara
Tokyo Stock Exchange, Inc.

The Next-generation Leader Exchange Session provided an opportunity to understand the current state of the securities industry and think about what we can do as providers of market infrastructure. As social issues become more serious, I feel that the meaning of such activities to strengthen collaboration within the industry is significant. In the future as well, I would like to collaborate with the people and organizations that support the industry, work to broaden the horizons of investment, and contribute to the sustained growth of the financial industry.



Taichi Takano
HIROGIN SECURITIES CO., LTD.

One of the greatest things I gained from it was the ability to confirm that securities companies, industry associations, and other involved parties with different standpoints were all working toward the common goal of “creating a better future for investors.” In order to respond to the needs of investors that change with the times, it is necessary for us to constantly identify changes and change ourselves as well. I would like to contribute to helping people achieve an abundant life by providing financial services that match the needs of the times.

Message from the Head of Corporate Headquarters

Contributing to a sustainable future through ceaseless self-transformation and resolute decision-making

Hidenori Anzai

Representative Director, Member of the Board,
Senior Executive Managing Director,
Head of Corporate Headquarters



Making our own choices, learning our own way

Throughout our history, we at NRI have stayed ahead of the times by adopting new technologies at a lightning quick pace for our progressive initiatives. Back when digital technologies still played only a small role in society, it was possible to clarify a policy and advance in a straight line toward a goal. The human resources and skills needed were clear. However, digitalization has progressed in rapid succession. Now, systems are the very essence of business. And technology is more important than ever. We have found ourselves in an age where it is unclear what even constitutes a competitive advantage. That is particularly why our clients require insight that is ahead of the times, and creativity to be able to dream up the future.

In our age of uncertainty, meeting this demand means seeking out the goals, policies, and paths forward on our own, among a broad range of possibilities. In other words, we believe that each of us must think individually about what we can do and what we want to do, then set our own goals accordingly. That does not mean abandoning or changing the skills that have carried NRI to where we are today. Rather, our approach is to value these skills while adding the skills needed to survive in the digital age. We refer to this as “+DX.” Based on this approach, we are creating new learning forums by establishing several training programs to refine the skills required in the digital age, from technological skills in cloud and data analytics to the human skills of mental strength and leadership. Employees make

their own choices, and go to our learning forums to elevate their skills. This is how we nurture professionals of substance who reinforce NRI’s competitive advantage.

Evolving work styles and co-creating job satisfaction

Employees must feel satisfaction and fulfillment from their work in order to fully harness their skills and capabilities and successfully implement our management strategy. We also believe that a culture that leverages diversity to break down tough challenges is necessary for each and every employee to feel true job satisfaction. The COVID-19 pandemic has forced us to change our outlook on work styles and work itself. Work styles that incorporate telecommuting have become the norm, and most communication has shifted from in-person to online. Job satisfaction is something that is fostered in the work environment and the mutual influences the employees working there exert on each other. Particularly since work styles these days are evolving so rapidly, we are pursuing our “co-creating job satisfaction” initiative to work together throughout the company at creating job satisfaction.

Raising employee engagement is essential in being able to create and improve job satisfaction. At NRI, we regularly conduct employee engagement surveys to measure their motivation toward proactively contributing to the organization and their psychological state on the job. We are working toward visualizing employee engagement. We are also working in unison to design various support programs to

address what we identify from the results of these surveys, and to do whatever else is necessary to create and improve employee job satisfaction.

Additionally, we are doubling our efforts toward diversity and inclusion in order to create workplaces that generate job satisfaction, where human resources with diverse values can continue to challenge themselves. NRI formulated an action plan to achieve at least a 30% ratio of female hires among new graduates in FY March 2023 and achieved it one year ahead of schedule. We are also establishing systems and environments that are even more conducive to female employee participation. Additionally, we have been stepping up efforts to create tolerant environments that value differences, with the aim of having workplaces where human resources of all different career backgrounds and generations can thrive.

Good work-life balance is also essential to any considerations about job satisfaction. NRI was early to seize upon telecommuting as a new work style that would unlock the maximum potential of employees and the organization, and we have been making company-wide efforts to incorporate it. When the state of emergency declaration was issued in Japan, we utilized telecommuting and reduced our office attendance ratio to 30%. Even after the COVID-19 pandemic is contained, we plan to actively implement work styles that enable employees to choose the best environments for their own productivity, with the general expectation of a 50% office attendance rate. Telecommuting is a tool we are using to actively engineer our own transformation. As NRI accommodates these new work styles, we will also be actively working to consolidate and reorganize our offices, which include handing over office spaces that are no longer needed.

We will be striving to create workplaces that offer a greater sense of job satisfaction and to foster a culture that yields positive cycles in which the diverse people who work there can thrive, challenge themselves, and produce results.

Reducing our environmental impact

The NRI Group recognizes that efforts to address global environmental issues, including climate change and environmental pollution, are common issues worldwide. As a leading IT company, we set environmental targets early on, and have made specific efforts such as joining the RE100 initiative and endorsing the TCFD Final Report. In response to the increasing global sense of crisis regarding climate change, we revised our target for limiting the rise in global temperatures from less than 2°C compared with preindustrial levels to less than 1.5°C, and received SBTi (Science Based Targets initiative) approval for the new target.

We believe that clients using the shared online services provided by NRI offers a drastic reduction in greenhouse gas emissions compared with those clients operating systems on their own. Going forward, we plan to actively transition to renewable energy sources to power the shared online services and cloud operations at NRI’s data centers. Currently, we are pursuing our goal of renewable energy usage at our data centers of 70% by 2030 and 100% by 2050. Our entire company is working toward the

procurement of renewable energy, with the ambition that we could achieve this goal even earlier than planned. We also intend to work continuously toward achieving our other environmental targets earlier than planned, including for greenhouse gas emissions in our supply chain. In FY March 2021, we accelerated initiatives to reduce our environmental impact, including the issuance of NRI Sustainability-Linked Bonds that commit explicitly to future improvements in sustainability outcomes. Leveraging both creativity and technological capability, NRI is working together with all of our stakeholders to reduce our environmental impact.

Governance that is globally viable

NRI is continuously working on better governance to support the sustainable growth of our company. As one of our growth strategies, we are improving our governance according to global standards in light of our current stated goal to expand business globally. This includes voluntary application of International Financial Reporting Standards (IFRS) and revising the NRI Group tax policy. In FY March 2021, we implemented the clawback system. At NRI we will continue striving to enhance our corporate governance for transparent and sound decision-making and, in doing so, contribute even more toward the creation of a sustainable future society.

Human Capital

NRI's Human Resources Strategy

The strength of NRI is our human resources; in other words, professional employees who possess a high level of expertise, who take the initiative to work on independently set goals, and who are fearless innovators. To develop these human assets, NRI has been strengthening a system and an environment to develop the hidden talents of highly motivated people and to allow them to produce results on the job.

Three Pillars of Our Human Resources System

NRI's human resources system is designed based on the three pillars of "assessments based on performance, outcomes, and ability," "discretionary labor scheme," and "a program of employee appraisals linked to human resource development." The program of employee appraisals linked to human resource development encourages employees to diversify and pursue specialized fields, thus supporting autonomous and systematic skill development by employees.

As an outline for pursuing specialized fields, NRI has defined 22 career fields (Figure 1) and encourages employees to refine their skills in multiple specialized fields. We develop human resources capable of collaborating across multiple departments by using a broad perspective to flexibly respond to changes in the business environment. NRI confers internal certification (Figure 2) to employees who possess a particularly high level of expertise in career fields. This promotes development of core human resources and provides employees with a role model of a professional.

Furthermore, each employee shares his or her target career field and level with his or her manager. Through interviews with managers held every six months, we implement a Challenge & Act (C&A) System for confirming the target set by employees and the corresponding level of achievement and an internal job posting and self-certification system that aims to increase opportunities for employees to choose their own careers and have the right people in the right places.

In addition to compensation for short-term performance, we have implemented incentives for medium- and long-term contribution; specifically, for the achievement of sustainable improvements in corporate value. Examples of incentives include retirement allowances, a defined contribution pension plan, employee stock ownership, and an E-Ship®*.

* Employee Share Holding Incentive Plan: Uses shareholding by employees to create the incentive of subsequent increases in share prices.

Career Fields (Figure 1)

1	Corporate strategy consultant
2	Business consultant
3	Systems consultant
4	Business strategist
5	Sales representative/Marketing manager
6	Project manager (Development)
7	Project manager (Enhancement)
8	Application architect
9	IT infrastructure architect
10	Application specialist
11	Common application infrastructure specialist
12	IT platform specialist
13	IT services manager
14	Security specialist
15	Researcher
16	Data scientist
17	Project management specialist
18	Quality management specialist
19	Business administration staff
20	Corporate management/Headquarters staff
21	Systems engineer
22	Consultant

Internal Certification Program (Figure 2)

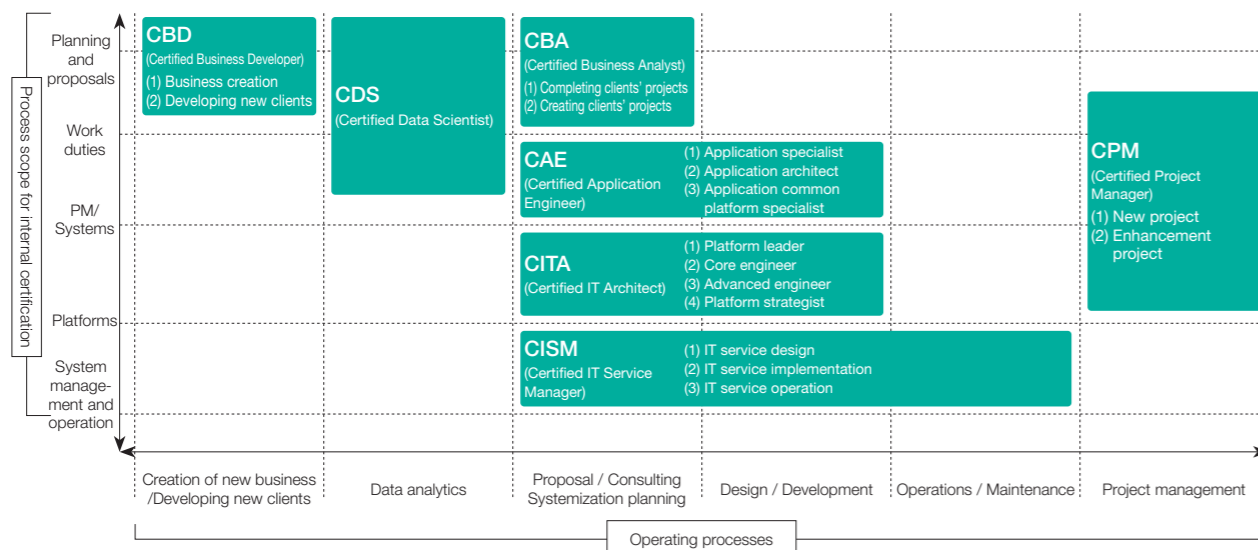

Human Resource Investment that is Top-Class among Japanese Companies

Human resources development at NRI is an organic fusion of three methods: training programs, self-improvement, and on-the-job training (OJT). NRI believes that providing OJT through work experience is the optimal development method. Training programs are a method for organizing knowledge acquired through OJT and deepening understanding. It is also positioned as a method for obtaining knowledge and skills that cannot be acquired through OJT. Our training program system (Figure 3) is generally divided into three program classifications. In addition to training at the time of receiving pay raises, Seniority-based Programs include programs for managerial talent development of selected individuals, for supporting women's participation and advancement, and for career development of tenured employees. Career Development Programs provide a variety of training programs that fulfill the diverse needs of employees, directed toward the development of individuals' capabilities in line with their career fields (Figure 1) and acquisition of in-house certifications. Diversity & Inclusion Programs offer programs geared toward diversity and work-life balance. NRI has also established a system to support self-development for employees to become qualified in and improve their foreign language skills.

Three Fundamental Elements of Human Resources Development

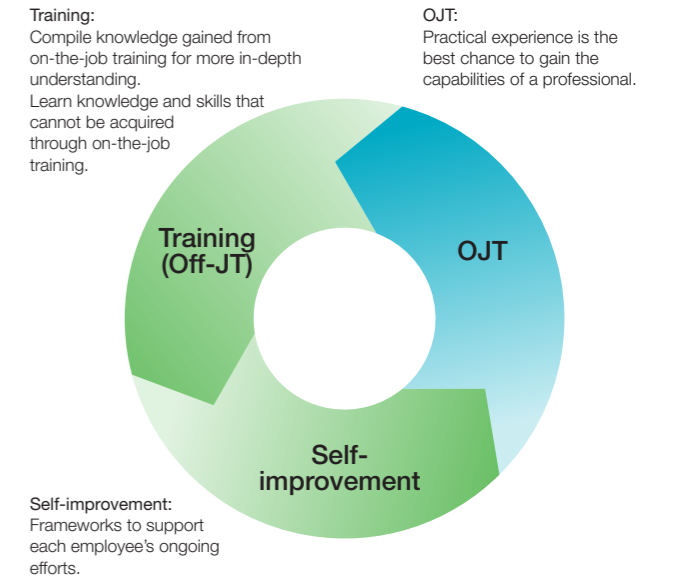

Global Human Resources Development Programs

NRI implements many overseas programs to develop global business leaders who can promote the Global Strategy, which is one of the growth strategies contained in the Medium-Term Management Plan (2019-2022). We are especially focusing on an overseas training system where employees can experience global business for about one year through an internship at the overseas office of a globally active client company. Over the past nine years, 190 trainees have so far been sent to 16 countries overseas.

The overseas studies program is a system through which employees obtain wide-ranging knowledge and expertise as well as advanced technical capabilities. In addition to MBAs from overseas business schools, the acquisition of degrees in other fields, such as computer sciences (MSE/MCS) and law (LLM), is also actively pursued.

Overseas assignments were halted during FY March 2021 due to worldwide COVID-19 pandemic, but we are sequentially resuming these assignments in FY March 2022.

NRI's Global Human Resources Development Program



Training Program System (Figure 3)

Classification	Junior employees		Mid-career employees		Senior employees		
	Assistant employees	Specialist employees	Deputy Supervisor	Supervisor			
Program according to seniority and position	New employee training	Training for promotion to specialist	Training for promotion to deputy supervisor	Training for promotion to supervisor	Training for promotion to senior employees	Training for new GM	Training for new department head
					Career planning workshop		
Career development program					Selected leader development program		
					Female leader development program	Female leader training program	Selected female department head and GM program
Priority fields	Consulting training				Selected GM training program		
	New employee training				IT solution skill training	Basic career training	Hands-on career training
D&I-related program	Human skills and other skill development program				Training for selected certifiers		
					DX human resources development program		
Other					Global human resources development program		
					E-learning related to diversity promotion, including unconscious bias and nursing care		
Other					Support for balancing work with childbirth, parenting and nursing care program		
					D&I seminar for department head and GM		
Other					Self-improvement support program		

Human Capital

Development of DX Human Resources

NRI implements a program to develop human resources who can accelerate the DX Strategy, which is a pillar of the growth strategies contained in the Long-Term Management Vision "Vision2022" and the Medium-Term Management Plan (2019–2022). Education to reskill and increase the capabilities of consultants and systems engineers, who already possess conventional abilities, is being carried out. This enables them to utilize their existing skills while expanding their area of activity to include the field of digital transformation (DX). By doing so, we are promoting the strategic shift of NRI's human resources portfolio to one that we are aiming for in the DX age.

DX Human Resources Development Program

With the aim of strengthening capabilities—such as those in artificial intelligence (AI), analytics, blockchain, UX design, agile software development, and microservice architecture—that are required in the DX age, NRI offers training for the acquisition of DX skills. The training is available across different lengths of service in addition to the traditional skills cultivation that takes place according to how long a person has been with the Company (Figure 1). There is a wide array of curriculums available. They include not only those for the acquisition of basic knowledge and IT skills but also courses that share implementation know-how, the latest business-use cases as well as deep insights, distinctive of NRI, and edgy business acumen.

Furthermore, proactive collaboration is carried out with research bodies (graduate schools, etc.) in Japan and abroad, external organizations, such as data scientist (DS) associations, and companies. A multitude of academic knowledge and progressive cases are incorporated to establish places of learning of a higher level as well as support employees in their development of human networks and stages for achieving success. Going forward, curriculums will be planned and designed around creating opportunities for learning, opportunities for development, opportunities for becoming connected, and opportunities for playing an active role. They will be adapted to providing chances for acquiring high skills of greater efficiency (Figure 2).

We are focusing on cultivating data scientists, such as by establishing "data scientist" as a career field in 2012, and institutionalizing "certified data scientist" in 2017.

Ranks have been established in accordance with skill levels for each capability to develop the human resources required for execution of the DX Strategy. Programs are planned and operated after establishing numerical targets in regard to the number of people to be cultivated.

DX Human Resources Development Policy (Aimed-for Ideal)

Based on the concept of "+DX" each employee will add on the following essences for surviving the DX age while leveraging the skills they have already nurtured through their careers, and they will aim to become human resources who will lead the DX age.

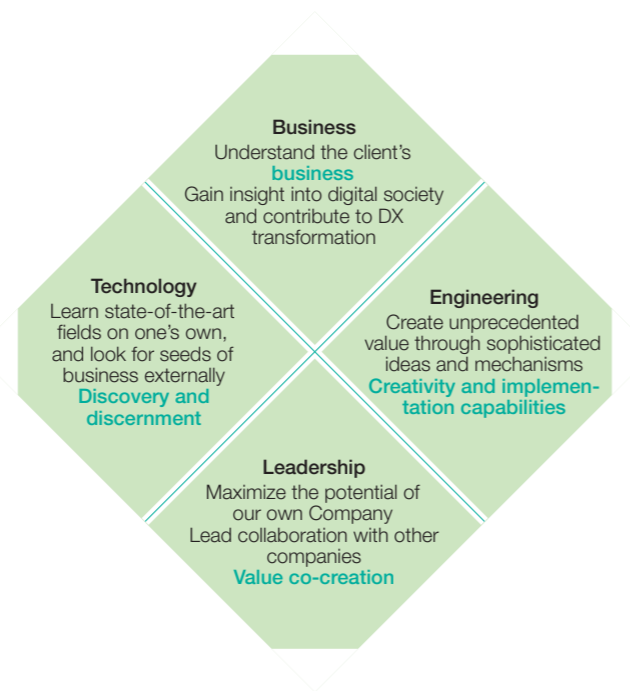

DX Human Resources Development Program (Figure 1)

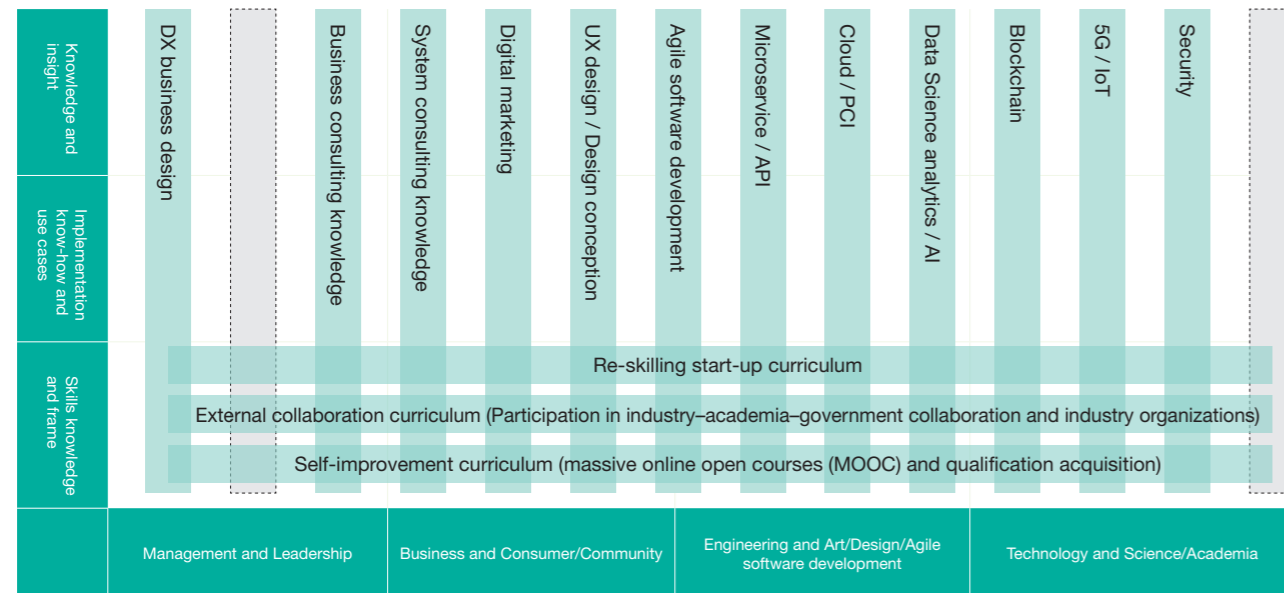

The Four Places of Learning (Figure 2)

1	Opportunities for learning	Each individual obtains opportunities to learn to challenges new fields	2	Opportunities for development	Individuals learn while contributing to the development of the next generation as an expert
<ul style="list-style-type: none"> • Training to share advanced knowledge distinctive of NRI and learn original insight, in addition to simple skills and case studies • Establishment of courses in which each individual can learn in accordance with their personal circumstances at their own pace as well as courses in which persons at any level, whether a beginner or veteran, can learn the basics • Self-improvement through Coursera*, university lectures, qualification acquisition, etc. <p>* Coursera: Providing e-learning courses through partnerships with roughly 200 universities and companies throughout the world</p>		<ul style="list-style-type: none"> • Plan internal training and development measures at DX Expert Panel meetings, and lead measures that promote the advanced integration of on-the-job and off-the-job training • Opportunities to develop the next generation by serving as lecturers of internal and external training sessions, and as university professors in industry-academia partnerships, taking the podium at events, and providing guidance to interns • Lead opportunities to teach others to even deeper learning through systematization and introspection 			
3	Opportunities for becoming connected	The enhancement of individual strengths by forming internal networks	4	Opportunities for playing an active role	Increase NRI's presence while also linking it to self-growth
<ul style="list-style-type: none"> • Participate in DX Expert Panel meetings and, based on human resources information and project information, lead measures for interaction between internal advanced human resources, sharing of insights, and the reinforcement of organizational strengths • Reinforce the functions of internal DX-related CoE* organizations, strengthen collaboration between consulting and solutions, invigorate job assignment through the discovery of candidates for advanced human resources, and promote the spread and popularization of advanced knowledge <p>* CoE (Center of Excellence) Organization: A cross-departmental organization within a company that brings together scattered people and knowledge</p>		<ul style="list-style-type: none"> • Make strategic assignment of human resources for information communication, such as through external lectures and newspaper and web-based articles, and to external collaborations, such as by dispatching individuals to industry organizations or having persons serve as executive board members of such organizations • Trigger personal growth through opportunities to strengthen NRI's branding 			
<ul style="list-style-type: none"> • Promote the integration of internal resources and information through these measures, and strengthen the display of capabilities by individuals 					

Job Satisfaction Co-Creation Forum

The Job Satisfaction Co-Creation Forum was held online in May 2021 with the goal of communicating management's stance on raising employee engagement and to have employees themselves aim to create workplaces conducive to job satisfaction.

At the forum, four experts from inside and outside NRI, including senior management, spoke about the importance of stimulating the organization through higher engagement. There were roughly 700 participants on the day of the forum, and over 250 more employees watched the video from the forum that was posted later.

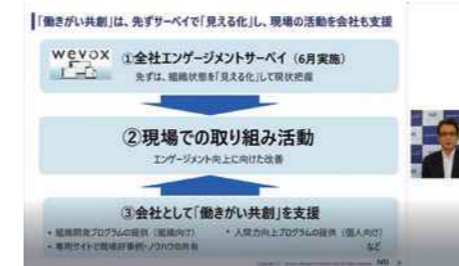

Projection video of the Job Satisfaction Co-Creation Forum

All training and seminars moved online

Training sessions and seminars attended in-person by employees could not be held due to the COVID-19 pandemic. However, nearly all of these were shifted to interactive livestreaming online where virtually the same content and activities were offered, including group work.

The smooth transition to online training made it possible to conduct the same level of human resources development activities as a normal year, with the Human Resources Development Department alone being able to hold 233 courses with 685 sessions overall (excluding e-learning courses and courses organized by the division) in FY March 2021.



Online training session taking place

Human Capital

Promoting Diversity and Inclusion, and Respect for Human Rights

NRI is promoting diversity and inclusion to promote employee success, which is in the Human Resources Strategy. Furthermore, we are engaged in the respect of the human rights of all people who are impacted by NRI's business activities.

Diversity and Inclusion at NRI

NRI believes that consolidating the strengths of each of its employees, with their various strengths and individual characteristics, leads to the strength of the organization. The Group aims to foster a workplace environment where diverse employees can all keep working positively and continue embracing challenges. To all employees, we offer e-learning content (e.g., understanding of unconscious biases and sexual minorities) that promotes understanding of diversity and inclusion. Additionally, in the past few years, related activities have prioritized three areas (gender, career/specialization, and generation) out of the seven areas shown in the figure on the right.

NRI Action Policy for Promoting Diversity and Inclusion

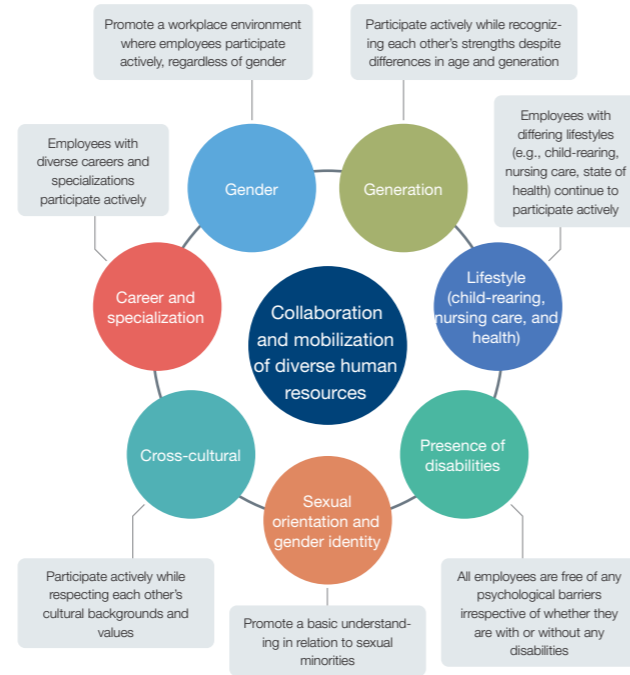

Action plans under the Act on Promotion of Women's Participation and Advancement in the Workplace

Term	From April 2019 to March 2023
Goals	<ol style="list-style-type: none"> 1. Raise the ratio of female managers to at least 8.5% by FY March 2023 (Newly promote more than 100 women to management level positions) 2. Raise NRI's female employee hiring rate to at least 30% of its total hires 3. Carry out, toward management-level employees, further awareness-raising activities related to diversity management
Initiatives	<ol style="list-style-type: none"> 1. Continue the Female Leader Development Program with the goal of developing female employees into managers 2. Continue measures to increase the number of female students recruited as employees 3. Implement awareness-raising measures related to management and development responsibilities of managers toward employees with diverse individualities and values 4. Carry out system reforms aimed at allowing employees to select diverse work-style choices

Initiatives for the Promotion of Women's Participation and Advancement in the Workplace

We are continuing our engagement in activities for the NRI Women's Network (NWN) project, which began in 2008 under the direct supervision of our president. When activities were first launched, an issue was women's turnover due to life events. We therefore created systems that supported the balance of work and parenting, prepared training, and fostered an environment that facilitated greater participation by women, making it only natural for women to continue working. Furthermore, we implemented measures to encourage women to advance their careers, including the Leader Development Program launched in FY March 2016, and the Leader Development Academy, in which female directors serve as instructors and was launched in FY March 2019. We thereby succeeded in boosting the female managers' ratio.

Discussions related to diversity promotion, including hiring women for management positions, are also taking place in Senior Management Committee and Board of Directors meetings. To facilitate the further hiring and promotion of women to director and management positions, we are engaging in the promotion of women's participation and advancement while keeping the job assignment and development plan in mind.

Initiatives for Promoting the Success of Mid-career Hires

NRI is strengthening mid-career hiring in order to promote the DX and Global Strategies. We are enhancing on-boarding measures when mid-career hires join NRI to enable them to become used to their new work environment as soon as possible and exhibit their expertise and capabilities to the fullest extent. From FY March 2021, we are holding a semi-annual exchange event for mid-career recruits and the president. Additionally, we interview mid-career hires who are doing well and publish articles for internal consumption.



Get-together of mid-career hires (held online)



Initiatives for Strengthening Intergenerational Integration and Synergy

Employees of a broad range of ages work at NRI, from those in their teens to their sixties. In regard to differences in thinking and values arising from generational differences,

there is a need to create an environment that enables people to recognize each other's strengths while respecting differences. In 2021, we worked to enhance the awareness of managers and department heads by holding a D&I seminar for them with generational inclusion as the theme.

Support for Balancing Work with Childbirth, Parenting, and Nursing Care

NRI is working to create a workplace that facilitates a balance between work and parenting for both men and women. In addition to systems such as maternity/paternity leave, we established the "partner childbirth leave" system in January 2017 as part of measures aimed at encouraging male employees to take paternity leaves and vacations. In June 2017, we opened the Yokohama Center and established the Yumeminato Hoikuen as an in-office nursery. These facilities support employees in resuming their career at the desired time and building a career plan.

Furthermore, to promote balance between work and nursing care, we have systems such as nursing care leave and shorter working hours for nursing care. We also hold nursing care seminars on a periodic basis.



In-office nursery Yumeminato Hoikuen



Promoting Workplace Participation by Persons with Disabilities

NRI Mirai, Ltd., a special subsidiary* of NRI, contributes to work-style reform by providing employees with various disabilities work opportunities such as setting up meeting rooms and libraries, supporting training, collecting/delivering internal mail, managing miscellaneous goods, and even providing massage services for employees.

Moreover, NRI is working to expand hiring opportunities for people with disabilities by holding fixed-point surveys and presentations related to management issues and trends in the hiring of people with disabilities and operations at special subsidiaries. As of June 2021, 181 disabled persons are employed at NRI and its Group companies (an employment ratio of 2.37%).

* It refers to a subsidiary that gives special consideration to promote the employment of persons with disabilities, and in doing so meets certain requirements. Obtaining certification from the central government allows persons with disabilities employed by this type of subsidiary to be deemed as being employed by the parent company.



NRI Mirai employees working at the magazines and books corner

Efforts for Respecting Human Rights

NRI considers respect for human rights an important social responsibility. On February 2019, NRI formulated its NRI Group Human Rights Policy based on international conventions such as the International Bill of Human Rights and the Guiding Principles on Business and Human Rights. Based on this policy, NRI is engaged in efforts toward respect for human rights. As a company involved in the development and utilization of AI, NRI also formulated the NRI Group AI Ethics Guidelines in October 2019 with the belief that it is essential to mitigate the negative effects of AI while developing and utilizing AI in a proper manner. Furthermore, as an initiative to entrench respect for human rights, we exercise human rights due diligence toward NRI and its Group companies based on the UN Guiding Principles on Business and Human Rights. In addition, we also carry out in-house training (e-learning) related to ESG, including human rights.

To further promote sustainable procurement, we are reviewing the terms and expressions used in the existing NRI Group Procurement Policy and the NRI Group Employees' Code of Business Conduct. Additionally, in April 2021, we established the NRI Group Business Partners'

Code of Conduct that outlines those matters that we would like our business partners to observe, including respect for human rights, compliance with laws and regulations, and preserving the global environment. Currently, we have made the Code known to our business partners, such as external contractors and procurement sources, and are seeking their understanding and cooperation.

NRI will continue to bolster its efforts toward respect for human rights while communicating with our stakeholders and facilitating their understanding of the relevant policies and efforts.

- NRI Group Policy on Human Rights**
<https://www.nri.com/en/sustainability/social/policies#jinken>
- NRI Group AI Ethics Guidelines**
https://www.nri.com/en/sustainability/social/policies#AI_Ethics_Guidelines
- Human Rights Report**
https://www.nri.com/-/media/Corporate/en/Files/PDF/sustainability/library/back_number/human_rights_report_e.pdf
- NRI Group Business Partner Code of Conduct**
https://www.nri.com/en/company/partner_code

Human Capital

Work-Style Reform Issues and Health and Productivity Management

By enacting work-style reform, NRI works to promote work-life balance by reducing long working hours. We seek to achieve an environment where employees can fully exhibit their abilities while valuing their personal health and family life.

Initiatives for Work-Style Reform

In 1994, NRI implemented a discretionary labor scheme that was a pioneering initiative in Japan at that time. Through this scheme, we have promoted a work style that is free from time constraints.

From 2016 to 2017, we relocated our Tokyo, Yokohama, and Osaka offices to new buildings. Based on the concept of “creating new value by connecting people, goods, events, information, and objectives,” we developed office spaces that achieve a working style that is uninhibited by location. The use of telecommuting and satellite offices is also increasing. Led by the Work-Style Reform Committee, which we started in FY March 2018, we are supporting the achievement of flexible working styles with even higher productivity. Although roughly 90% of NRI employees telecommuted while the April 2020 COVID-19 state of emergency declaration was in effect, we were able to continue providing services that did not differ from normal times. Currently, we are engaged in enhancing productivity through a new work style that combines telecommuting with in-office work. The percentage of people coming into the office to work has been set at 30% when a state of emergency declaration or pre-emergency measures are in effect.

At all other times, the attendance rate has been set at 50%. In addition to this work infrastructure, NRI is also fostering a corporate culture that facilitates co-creation among diverse human resources. For example, one specific initiative is work-style reform that matches the content and characteristics of work at each division.



New office that achieves an innovative working style

NRI Health Declaration 2022

Basic policy: Based on correct knowledge and recognition for their own health by each employee, the NRI Group supports active initiatives for improving long-term QOL.

1	Reduce lifestyle-related diseases <ul style="list-style-type: none"> • Manage employees' reservations and receipts for medical check-ups and health examinations, and encourage them to take these examinations • Put in place health management rooms at our principal offices and build a framework for industrial doctors to handle cases
2	Lower stress <ul style="list-style-type: none"> • Stress prevention for individual employees and teams • Develop a system to enable employees to return to work earlier
3	Lower smoking rates <ul style="list-style-type: none"> • Introduce support to help stop smoking • Remove smoking spaces inside the office
4	Promote work-life balance <ul style="list-style-type: none"> • Reduce overtime and holiday work hours • Encourage employees to take paid leave • Implement the frontline-driven Smart Work-Style Campaign (SWC) including: streamlining operations and meetings, as well as promoting early morning work

Health and Productivity Management

NRI aims to achieve health and productivity management* that helps improve employees' quality of life (QOL). The CEO of NRI also serves as Chief Health Officer (CHO) and currently is developing various systems and engaging in the relevant initiatives toward invigorating NRI and achieving increased productivity under the four goals.

* This refers to a business policy that generates benefits for a company by providing its employees with health-related assistance. This term is a registered trademark of the Workshop for the Management of Health on Company and Employee.



External Evaluation of NRI

- In 2017, NRI received the highest level (Level 3) of Eruboshi Certification (certification by the Minister of Health, Labour and Welfare based on the Act on Promotion of Women's Participation and Advancement in the Workplace)
- Selected as a Nadeshiko Brand for five consecutive years in a row (corporations selected by the Tokyo Stock Exchange and the Ministry of Economy, Trade and Industry for outstanding promotion of female performance and advancement)
- Certified as “Kurumin” for five consecutive terms from 2007 and as “Platinum Kurumin” in 2018 (certification of corporations that support child-rearing based on the Act on Advancement of Measures to Support Raising Next-Generation Children)
- Certified as a Health and Productivity Management 500 Organization (White 500; Large Enterprise Category) for five consecutive years in a row



Social and Relationship Capital

Cooperation with Stakeholders

NRI's stakeholders, mainly consisting of clients, employees and their family members, shareholders, investors, and business partners, include a wide range of entities composed of general consumers, media, local communities, industry associations and competitors, government agencies, education/research institutions, students, and NGOs/NPOs.

Cooperation with Clients

NRI engages in sincere business activities for its clients and strives to deliver services that are satisfactory and in conformity with client agreements.

Comprehensive deliberation on new contracts

In response to business contract requests from clients, we decide to accept them by conducting examinations. We make our final decision after thoroughly considering the fiduciary duty on quality and delivered date, as well as legal, ethical, and operational risks for the contract.

Client satisfaction surveys

NRI conducts client satisfaction surveys for each project and has clients evaluate the entire project. We also obtain specific feedback from clients on our proposal-making skills and incident-management procedures.

The Quality Management Department compiles and analyzes overall trends through the results from the survey. It also provides the departments in charge of the project with feedback from the surveys and implements measures to follow up on the feedback and enhance service quality, leveraging the data to improve the service quality.

The Main Items for Deliberation on New Contracts

- Credit screening tapping into information from research firms
- Project-by-project deliberation at the Senior Management Committee and each division meeting
- Comprehensive assessment on the future potential, growth potential, and social effects of the business

Results of the Client Satisfaction Survey (non-consolidated) Percentage that responded “Satisfied” or “Moderately satisfied” (Total for top two items on five-grade scale)

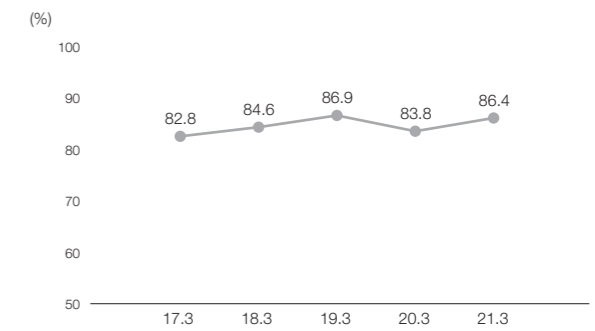

The investigation targets all business units. Clients and project services that will be the target of the investigation are selected for each business unit based on set criteria.

Cooperation with Business Partners

NRI's operations are based on cooperation with its business partners, such as external contractors and suppliers. Accordingly, NRI has a fundamental policy of building business relationships that are mutually beneficial, as well as obey sound business practices and laws.

NRI Group Procurement Policy
<https://www.nri.com/en/company/partner>

When an NRI system development project is contracted out to a business partner, it should be assessed comprehensively with respect to its technological capability, quality, delivery date, cost of products and services, staffing and platform, financial condition, compliance, and efforts on information security management. Overseas business partners should also be screened under laws such as the Foreign Exchange and Foreign Trade Act.

The number of employees involved in business at NRI's business partners stands at approximately 12,000, about half of which are permanently stationed in NRI offices or currently working from home.

To continue the appropriate contract services, we formulated the Guidelines Relating to Contract Work. Moreover, we separate the work sites of business partner employees under a contract service agreement from the work site of NRI employees, preventing a practice of falsified contract service in which an NRI employee directly issues instructions and orders to a business partner employee. We annually conduct the required self-inspections.



Hosting of Partner Sustainability Dialogues

NRI holds annual sustainability workshops with its business partners to share information and exchange opinions about sustainability activities. The dialogue was held online for the first time in January 2021. There was participation by a record 53 business partners, a testimony of their strong interest in sustainability activities.



Dialogue with business partners regarding the ideal nature of cooperation in sustainability activities

Social and Relationship Capital

Dialogue with External Experts

Talks with the CEO of the World Business Council for Sustainable Development (WBCSD)

In September 2020, we received a request from WBCSD CEO Peter Bakker to hear the thoughts of President Konomoto on the impact of the COVID-19 pandemic on NRI.

In the dialogue, Mr. Bakker described the state of the global business community under the COVID-19 pandemic and the stakeholder capitalism actionable project that leads sustainability performance to investment. He spoke of his expectations toward NRI, which possesses knowledge related to finance and IT.

Meanwhile, NRI described how industry's metabolism will be promoted after the end of the COVID-19 pandemic, companies will need to transform their business model, and NRI will lead the transformation of companies from the aspects of both consulting and IT. Furthermore, it was

explained that, in regard to stakeholder capitalism, NRI is advancing research on databases to appropriately match investors with companies requiring funds.

To continue to be an indispensable existence for the world toward the Group's sustainable growth, NRI is promoting global collaborations for solving the social issues that are arising on a global scale.



WBCSD online meetings



Dialogue with WBA

Dialogue with the World Benchmarking Alliance

In October 2020, dialogue was carried out with the World Benchmarking Alliance (WBA), an international NGO that promotes the Sustainable Development Goals (SDGs). Opinions were exchanged on such topics as corporate value from the perspective of the SDGs, and how disclosure should be made in regard to human rights-related initiatives.

Status of Response to Issues Identified in Past Dialogue

NRI is improving its ESG initiatives and risk management based on the pointers acquired through dialogue with various stakeholders.

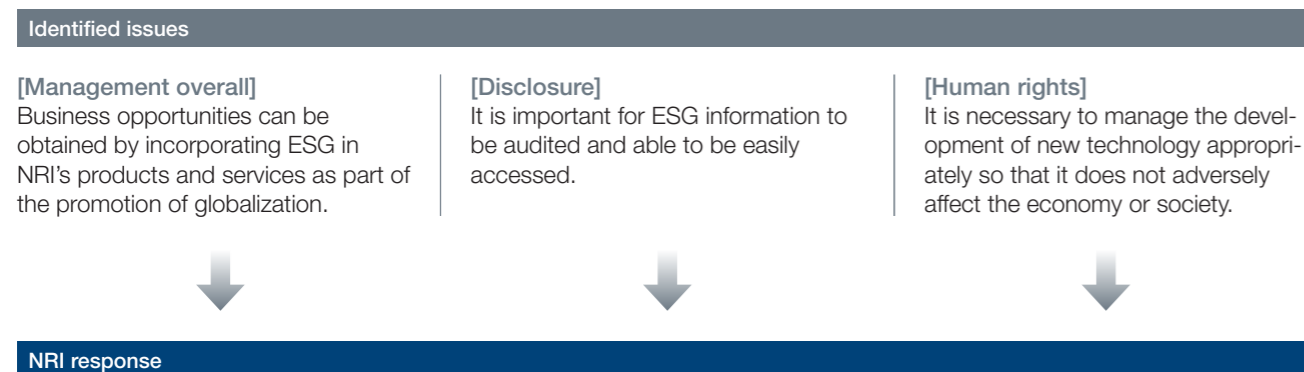

Information Disclosure and Communication

NRI is committed to gain the trust of shareholders and investors through constructive dialogue, and to receive an appropriate evaluation from capital markets. For these reasons, taking fair disclosure as our fundamental policy, we are working to promote understanding of both our business and our medium- to long-term strategies for growth, and to expand our shareholder and investor base.

Measures Aimed at Ensuring a Meaningful General Meeting of Shareholders

To energize the General Meeting of Shareholders and ensure that voting rights are exercised, we perform the following procedures:

- Set the date of the General Meeting of Shareholders on a day where such meetings are not concentrated. In addition to sending out individual notices of convocation of a General Meeting of Shareholders earlier, post the notice on the NRI and Tokyo Stock Exchange websites prior to sending the individual notices. This effort allows shareholders to have sufficient time to consider the proposed resolutions for the meeting
 - Deliver a notice of convocation of a General Meeting of Shareholders in English (summary)
 - Provide an opportunity to exercise voting rights by using the Internet system run by a trust bank (a shareholder register administrator)
 - Provide an opportunity to exercise voting rights by using the Voting Rights Electronic Exercise Platform, run by ICJ, Inc.
 - Hold a Management Reporting Session for shareholders after the conclusion of the General Meeting of Shareholders
- The 56th Ordinary General Meeting of Shareholders: Notice released on May 21 → Meeting held on June 18 (Notice about one month before)
- Send out a notice of convocation of a General Meeting of Shareholders electronically to shareholders consenting to such procedure

Active Dialogues with Shareholders and Investors

With the aim of expanding our shareholder and investor base, we are promoting better understanding of our business activities and strategies for growth through direct and indirect communication. The following principal activities were implemented during FY March 2021:

For shareholders	<ul style="list-style-type: none"> • Shareholder questionnaire: Number of respondents: 4,139 (Number sent: 14,538 shareholders / Collection rate: 28.5%)
For institutional investors and analysts	<ul style="list-style-type: none"> • Number of investors met: 713 persons • Domestic: In addition to results briefing sessions for each quarter and individual interviews, held small meetings with management, ESG briefings, Business Information Sessions, etc. • Overseas: Online roadshows and online conferences
For individual investors	<ul style="list-style-type: none"> • Individual investor information meeting: two were held (Online) • Number of attendees: 1,430 persons

Hosting of ESG Briefings

We host "ESG briefings" to help investors, analysts, and the media gain an understanding of NRI's sustainability management and specific efforts regarding ESG. The February 2021 briefing welcomed 106 participants.



ESG briefings
<https://www.nri.com/en/sustainability/management/esg/2018>

Providing Appropriate Information Disclosure

In order to achieve accountability to shareholders, investors, and other stakeholders, NRI is striving to enhance the level of information disclosure and the timely disclosure of information through activities including those below.

- Disclosed the Long-Term Management Vision and the Medium-Term Management Plan (mid-and long-term management strategy and numerical targets, etc.)
- Established the Disclosure Committee, which checks the preparing process for, and appropriateness of, disclosed materials
- Published our financial results and latest information promptly under the Investor Relations section on our website
- Provided a dedicated website for individual investors to enhance information disclosure and understandability and clarity

External Evaluation of NRI

2020 Award for Excellence in Corporate Disclosure
 · IT Service / Software Industries
 · Disclosure to Individual Investors
 (The Securities Analysts Association of Japan)



Manufacturing Capital

NRI's Quality Management

We continually work to improve the quality of services, fully aware of our responsibility to deliver and operate information systems that serve as a key component of social infrastructure.

NRI's Quality Management Framework

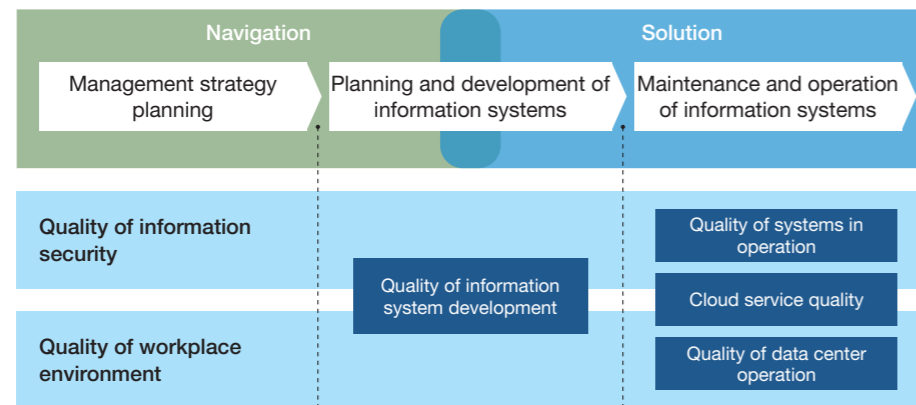

Initiatives for Improving the Quality of Information Systems

Each division is responsible for quality management over system development, maintenance and operations, and consulting services projects. In addition, NRI has an organization that proposes and supports quality management activities for each division.

In addition, work is under way to post all of the knowledge gathered at NRI on its internal website in order to share expertise and examples across the entire Company.

Project Support System for Improving the Quality of Information Systems

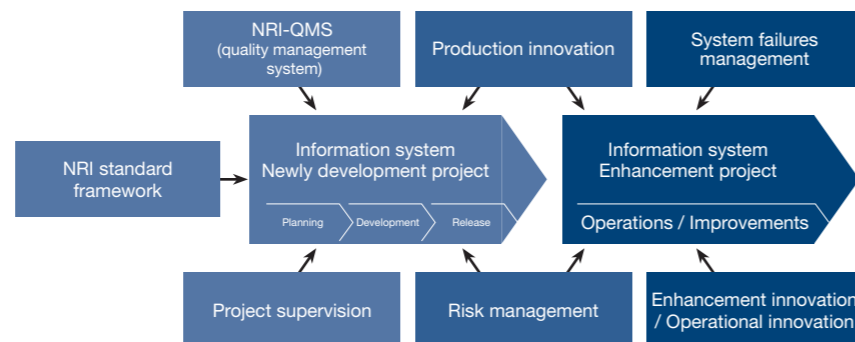

Project Supervision Activities to Support the Quality of Information System Development

The Quality Management Division provides both supervisory and project management office functions for each individual division, when they develop a new information system. In addition to "project management" for project implementation and success, NRI has a "project supervision" function to propose quality improvements, and to identify and resolve issues early on.

To ensure that internal reviews are not merely process checks, committee members gathered from each division enact a strict check through the system details, thus achieving a high level of quality.

Project Supervision Activities

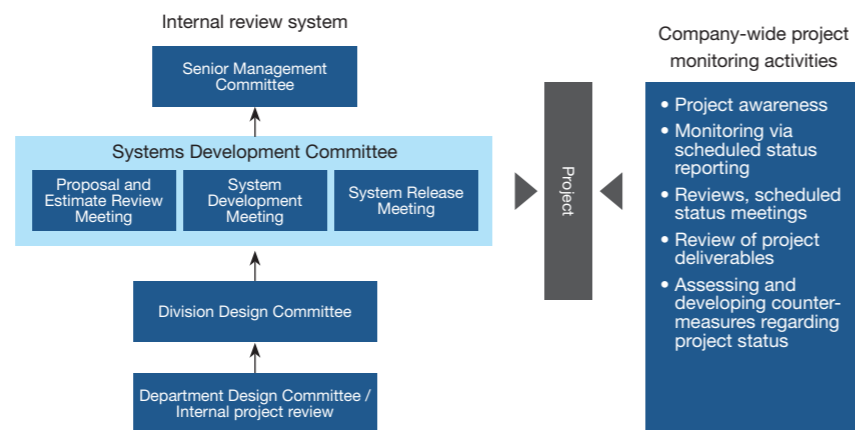

Emphasis on Quality of Systems in Operation

Operating and maintaining completed information systems of a high quality not only builds solid relationships with clients but also provides opportunities to improve and propose new solutions for the streamlining and further growth of clients' businesses.

For this reason, NRI refers to operations and maintenance projects as "enhancement projects," which are assigned the same level of importance as projects to develop new information systems.

Production Innovation Initiatives

Since FY March 2011, NRI has held the Production Innovation Forum for each business division to share its initiatives related to productivity and quality improvements in a company-wide manner, and to recognize innovative initiatives. In FY March 2021, NRI explained its internal initiatives related to the 2025 digital cliff and new technology, such as AI, under the theme of "how to deal with the digital cliff and new technology and meet the expectations of clients."

We will continue to make endless improvements as a leader of the IT services industry and foster a corporate culture of taking on new challenges.



The Production Innovation Forum award ceremony

Cloud Service Quality that Supports Social Infrastructure

Cloud services communally used by large numbers of users serve the function of supporting social infrastructure. These services must be operated safely and securely.

NRI sets standards internally based on guidelines issued by relevant agencies, performs risk assessments on a regular basis, and takes the appropriate measures. We also have independent organizations perform regular audits and evaluations of the operations of these services, and facilitate improvement processes to ensure that they remain highly regulated with good security.

Quality of Data Center Management that Supports Stable Operations

The stable operation of information systems requires not only the quality of the information system itself but also the quality of the data center that operates and manages the information system. In order to ensure stable operation of information systems, and to provide safe and secure quality of services, NRI visualizes the risks related to data center services, conducting training for each type of issue that could be anticipated.

It also conducts inspections that are interconnected with data center facilities. In respect to these efforts, NRI has obtained certification from third-party review agencies.

Safety and Security Forum

The stable operation of data centers is NRI's social mission. As part of this mission, we hold a forum on the themes of safety and security every year. The forum served as an opportunity for employees to pledge to the stable operation of information systems, with lectures on safety by external experts centered around the concepts of thinking, learning, and not forgetting, and awards for excellent slogans on safety and security thought up by individual employees.



Video content from the Safety and Security Forum (excerpts)

Examples of Certifications and Assurances Acquired by NRI

- ISO9001 (Quality management system)
- ISO14001 (Environmental management system)
- ISO20000 (IT service management)
- ISO27001 (Information Security Management System)
- ISO27017 (Cloud services security)
- SOC 1/SOC 2 Report (Internal control assurance report)
- Uptime Institute M&O (Global certification standard for data center management prescribed by Uptime Institute)*



* Certification acquired for Tokyo Data Center I, Yokohama Data Center II, and Osaka Data Center II

Manufacturing Capital

Quality of Information Security

NRI operates important infrastructure that supports society including finance and distribution. We have established an advanced information security framework to continue service and protect important information at all times, and through that framework, we work to remain a trusted partner to our clients and society.

Policies Relating to Information Security

NRI and its group companies declare that the NRI Group shall observe all applicable laws and ordinances and shall fully recognize the roles that companies offering information services should play. The NRI Group has established a framework of advanced information security management that can serve as a social model to enable its companies to continue to be worthy of client and public trust.

 Declaration of Information Security Measures
https://www.nri.com/en/site/security_declare

Related Rules Concerning Information Security

In response to laws and regulations related to information security and the advance of information technologies, we establish or revise management rules as appropriate, including the Information Security Management Rules, Confidential Information Management Rules, Personal Information Management Rules, Specific Personal Information Management Rules, and Information Asset Management Rules.

In addition, we have prepared operating procedures, guidelines, manuals, etc., for each of these management rules to ensure that consistent and effective information security management is conducted.

Information Security Management Structure

NRI has appointed a Chief Information Security Officer, who has developed a system of information security management for our organization as a whole. All business divisions and Group companies have appointed an information security manager and information security person-in-charge (PIC), who have developed a mesh structure that allows security measures to be undertaken on a cross-organizational basis. As well as furthering the implementation of our information security policies, this structure will enable us to respond swiftly, accurately, and reliably in the event of cyberattacks and other security emergencies.

The NRI Group contains specialist organizations that conduct surveys and research of the latest information technologies, as well as NRI SecureTechnologies, Ltd., (hereinafter, "NRI Secure") that engages exclusively in information security business. We will draw on their technology, know-how, and knowledge when preparing and implementing our information security policies.

We have appointed an information security manager and an information security PIC at each of our overseas and domestic group companies, who are directing the development of an effective information security system and the drafting of an information security enhancement plan at their company. In addition, the NRI Group has set certain information security protection standards and engages in improvement drives designed to meet those standards.

Information Security Management Structure

Planning and implementation

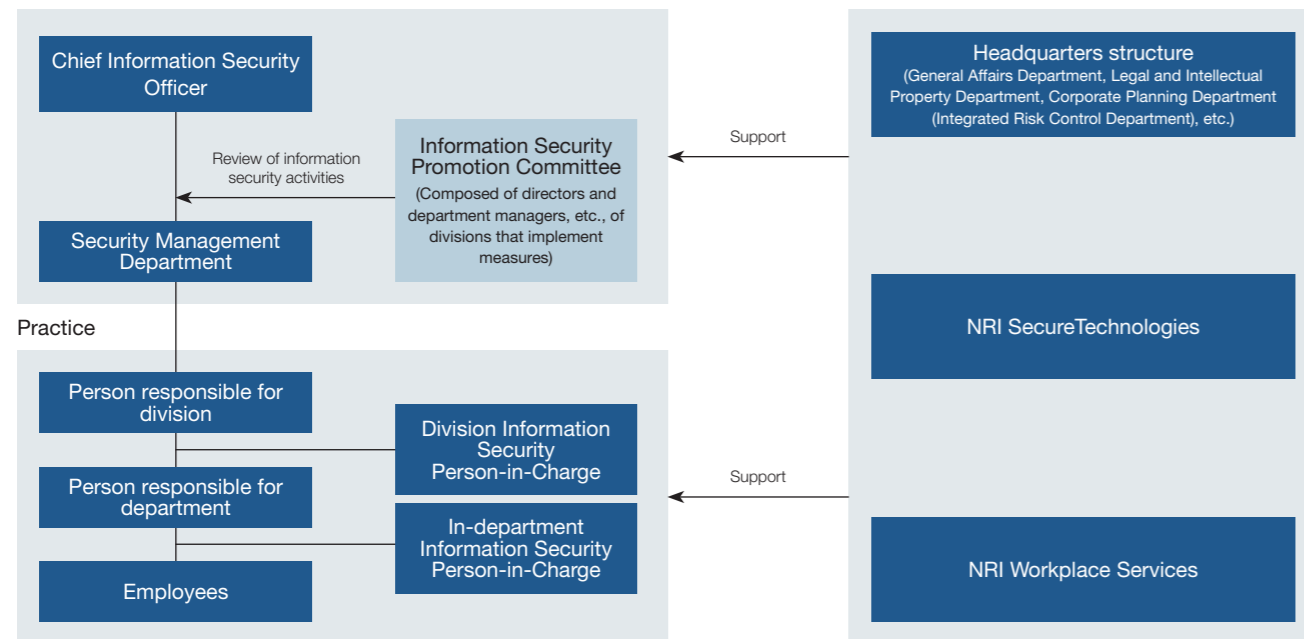

Education on Information Security

NRI conducts ongoing information security education to raise the awareness of information security, instill regulations, and improve the quality of security during design and development. In addition to conducting specific training tailored to the particular characteristics of our divisions and group companies, we arrange training for our overseas offices that can be undertaken in English and/or Chinese. We also actively incorporate group training and e-learning methods into our training programs.

NRI's Handling of Personal Data (Including Individual Numbers)

NRI has a Personal Data Protection Statement, and it has made its Privacy Policy available to the public. In accordance with the Statement and Policy, our employees comply with the Act on the Protection of Personal Information Held by Administrative Organs; the Act on the Use of Numbers to Identify a Specific Individual in Administrative Procedures (the "My Number Act"); and other relevant laws and regulations.

NRI demonstrates flexibility in its responses to changes demanded by the public, such as keeping abreast of rules and guidelines on the protection of personal information issued by regulatory authorities by the Personal Information Protection Commission.

 Personal Data Protection Statement
<https://www.nri.com/en/site/security>
 Privacy Policy
<https://www.nri.com/en/site/privacy>



Response to Cyberattacks

NRI uses system-based defenses against cyberattacks, such as installing antivirus (anti-malware*) software, hard drive encryption, and installing different security measures (such as firewalls, WAF**2, and network behavior analysis technology**3). However, NRI is well aware that just system responses alone are not enough for defense, and to that end it is putting in place a Computer Security Incident Response Team (CSIRT**4).

A CSIRT acts like a fire extinguisher, denying further success to any attack that does in fact strike a system. It collects, evaluates, and shares vulnerability and attack information that is organized, swift, and appropriate. We also conduct for our employee's education and training.

*1 Malware, or "malicious software," is a software program that upon infecting a computer automatically takes remote control of that computer, either stealing data that it stores or causing it to attack other computers.
 **2 Web Application Firewall: System for detecting or providing protection against attacks that take advantage of the vulnerabilities of web applications.
 **3 Malware used in a phishing attack is often produced to target a specific company alone, which means general antivirus software may not be able to detect and eliminate the attack. NBA technology works by running software suspected of being malware in a highly restricted environment called a "sandbox." Checks are then made to see whether the software is engaging in behavior such as information exploitation or preparatory activity to that end, and if it is, it is eliminated.
 **4 Computer Security Incident Response Team: This is the entity (a team) that takes the appropriate response when it receives notice of a computer security incident. Alternatively, CSIRT refers to the functions of that entity.

NRI Secure Recognized as an Information Security Market Leader by Research Firms in Japan and Overseas

As part of the "Best Practice Award" released by the major U.S. research and consulting firm Frost & Sullivan Inc., NRI Secure was named the "Japan Managed Security Service Provider of the Year," the top award in the Managed Security Services category, for the fourth year in a row. Furthermore, NRI was introduced as one of the representative global vendors in reports published by U.S.-based Forrester Research related to managed security services providers and fraud management solutions.

Received the 2020 Japan Managed Security Service Provider of the Year award from Frost & Sullivan



Quality of Workplace Environment

NRI promotes a multitude of initiatives to foster a workplace environment where employees can keep on working positively in good mental and physical health. The buildings for Headquarters, the Yokohama Center, and the Osaka Center have open layouts with no assigned seating, and common spaces such as meeting rooms. NRI is working to create better places to work through innovation in work styles and by reconceptualizing the organizational atmosphere. Such efforts include the introduction of a framework for allowing project managers, and those in project supervisor departments, to grasp the overtime hours of project members. NRI is also

continuously working on advancements in our work environments themselves. This includes digital solutions implemented starting in June 2020 that use in-house technologies to protect the health of visiting clients as well as employees of NRI and its partners by detecting body temperatures of visitors and avoiding the "Three C's" — closed spaces, crowded places, and close contact with people, in the office.

Natural Capital

Environmental Impact Reduction Activities for Preserving the Global Environment

One of the key issues (materiality) for sustainable growth raised by the NRI Group is environmental impact reduction for preserving the global environment. All officers and employees are striving to reduce the environmental impact.

Environmental Targets

The environmental target set by the NRI Group in FY March 2019 was certified under the Science Based Targets initiative (SBTi)*1, an international environmental initiative, as a 2°C target or a pathway to limiting global temperature rise to below 2°C from preindustrial revolution levels. Later, in May 2020, NRI committed to Business Ambition for 1.5°C, in response to the mounting sense of crisis related to global climate change. In February 2021, NRI set a greenhouse gas emissions reduction target that aimed to limit global temperature rise to 1.5°C from preindustrial revolution levels. The target has been certified by SBTi as a 1.5°C target. To achieve this target, NRI has changed the target for the renewable energy utilization rate by NRI Group data centers, from 36%, which was set when joining RE100**2 in FY March 2019, to 70% in FY March 2031.

*1 SBTi: An initiative to promote the setting of science-based targets for reducing greenhouse gas emissions by companies in order to control the increase in global temperature below 2°C from preindustrial revolution levels. The initiative was established by four organizations: CDP, which is a federation of institutional investors promoting disclosure on climate-change countermeasures, the UN Global Compact (UNGC), the World Resources Institute (WRI), and the World Wildlife Fund (WWF).
*2 RE100: An international initiative operated through a partnership between the CDP and The Climate Group (an international NGO). Member corporations have publicly declared that they will transition to 100% renewable energy for electric power consumed in business activities by 2050.

Science Based Targets website
<https://sciencebasedtargets.org/>
RE100 website
<http://there100.org/>

NRI Group's Environmental Targets

Category	Initiatives
Scope1+2	Target for FY Mar. 2031
	Reduce greenhouse gas emissions at the NRI Group by 72% (compared with FY March 2014)
	Achieve a renewable energy usage rate of 70% at data enters
	Target for FY Mar. 2051
	Reduce greenhouse gas emissions at the NRI Group to zero
Scope 3	Achieve a renewable energy usage rate of 100% at the NRI Group
	Target for FY Mar. 2024
	70% or more of NRI Group suppliers and vendors will set science-based target for reducing greenhouse gas emissions (Categories 1, 2 and 11)
	Target for FY Mar. 2031
	Reduce greenhouse gas emissions related to employee travel and commuting (Categories 6 and 7) by 25% (compared to FY March 2014)

Scope: Target scope of calculation/reporting for greenhouse gas emissions by corporations
Scope 1: Direct emissions through combustion of fuel, etc.
Scope 2: Indirect emissions through use of electricity, heat, steam, etc.
Scope 3: Indirect greenhouse gas emissions other than Scopes 1 and 2. Manufacturing in the supply chain, commuting by employees, business travel, etc.

In March 2021, we issued NRI Sustainability-Linked Bonds**3, which are linked to the aforementioned greenhouse gas emissions and renewable energy utilization rate by NRI Group data centers. The bond has adopted a mechanism for having investors agree with and support the achievement of NRI's environmental target in FY March 2031. The NRI Sustainability-Linked Bonds were selected as Refinitiv Japan K.K.'s Innovative Debt Deal of the Year in the corporate bond category of the DEAL WATCH AWARDS 2020.

*3 Sustainability-Linked Bonds are bonds with terms that change depending on whether sustainability/ESG targets specified in advance can be realized. Issuers of Sustainability-Linked Bonds commit to improving outcome related to future sustainability within a time frame specified in advance. Specifically, Sustainability-Linked Bonds are financial instruments based on future performance that is evaluated by key performance indicators ("KPIs") and sustainability performance targets ("SPTs") specified by the issuer in advance, and the terms of such bonds will change depending on whether SPTs, which are set as target values to be realized in relation to KPIs, are realized.

Results and Annual Targets of Greenhouse Gas Emissions (Scope1+2)

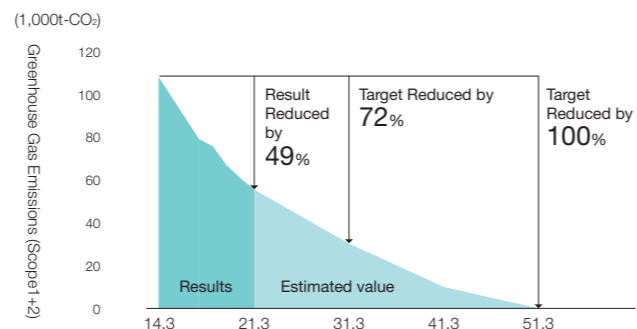

Award plaque for the Innovative Debt Deal of the Year

Actual Greenhouse Gas Emissions

From FY March 2016, NRI has been relocating and consolidating operations into data centers and offices with high environmental performance. As a result, the NRI Group's greenhouse gas emissions (Scope1+2) in FY March 2021 were 55,000 tons, which was a reduction of about 49% from FY March 2014. Going forward, we will engage in the reduction of GHG emissions by promoting

renewable energy procurement in addition to our conventional energy conservation measures.

Implementation of Environmental Management System

NRI has acquired ISO14001 certification, an international standard on environmental management systems, for its data centers, which are the main source of CO₂ emissions. Furthermore, NRI-EMS, an environmental management system unique to NRI, has been introduced at key NRI offices. Starting with implementations of NRI-EMS at offices in China in FY March 2019, we will be implementing the system at more worldwide offices going forward.

Target Scope for Environmental Management System (based on CO₂ emissions)

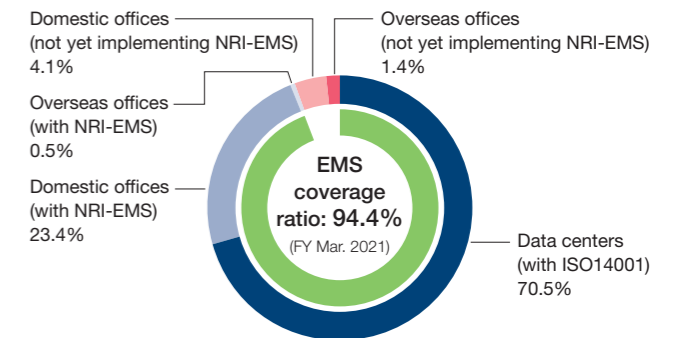

Progress in Renewable Energy Procurement

Because 90% of the NRI Group's greenhouse gas emissions arise from the use of electricity, we are sequentially promoting a switchover to the use in business of electrical power derived from renewable energy. As for our offices, thanks to efforts such as the lobbying of building owners, a switchover from FY March 2022 to the use of electricity derived from renewable energy has been decided at

some offices. Meanwhile, at our overseas bases, we achieved net-zero GHG emissions in three regions—China, the U.S., and Australia—by purchasing renewable energy certificates. To achieve our target of making the renewable energy utilization rate by our data centers 70% by FY March 2031, we launched a company-wide decarbonization project in February 2021.

ESG Training for Employees

We believe that spreading the NRI Group's sustainability policy to each officer and employee, and having them engage in their daily duties with an awareness of the key issues for sustainable growth is of importance in the implementation of sustainability efforts. To enable this, we opened our intranet ESG Site in November 2020 as a means to build awareness and familiarize employees with the

necessary knowledge and wisdom, including those matters that need to be observed. Through the ESG Site, employees can learn about the global tides related to ESG from each of the themes—Environmental, Social, and Governance. What is more, employees can also learn about and deepen their understanding of the sustainability activities that the NRI Group is engaged in.

External Recognition

For the second year in a row following FY March 2020, NRI was selected, through the climate change survey carried out by the international non-profit organization CDP*, as a Climate Change 'A List' company, which is the CDP's highest level of recognition. We believe that NRI was recognized for its strategy, initiatives, and information disclosure pertaining to climate change.

NRI's initiatives to address climate change in its supply chain were also recognized for the second year in a row in February 2020 by selection to the Supplier Engagement Leaderboard—the highest rating assigned to companies in the Supplier Engagement Ratings by the CDP.

Going forward, all NRI officers and employees, together with our business partners, will promote transparent environmental impact reduction activities toward creation of a sustainable society.

* CDP: A non-profit mainly involved in compelling companies and local governments to disclose information at the request of highly environmentally aware institutional investors and major purchasing companies about their climate change measures and measures for environmental problems such as safeguarding water resources and protecting forests, and subsequently encouraging them in following through on these measures. CDP is an information disclosure platform that currently provides the world's most useful information pertaining to environmental problems.

CDP website
<https://www.cdp.net/en>



Natural Capital

Initiatives for the TCFD Final Report

NRI's Initiatives Regarding the TCFD Final Report

The NRI Group established our Sustainability Activities Committee to carry out initiatives upholding value co-creation in sustainability management by implementing initiatives related to sustainability management.

Because we consume a large amount of electric power—mainly at our data centers—the NRI Group acknowledges the importance of the effect electricity usage has on the climate. We announced that the NRI Group endorses the TCFD*1 Final Report (“TCFD”) in July 2018, and we are appropriately disclosing information based on the TCFD framework. Repeated discussions are being held in the Sustainability Activities Committee together with experts from

the consulting business division, and in FY March 2018 we began publicly releasing information about our progress at the annual ESG Briefing*2.

In FY March 2018, we identified risks and opportunities throughout the NRI Group's overall business. In FY March 2019, we conducted a scenario analysis for the data center business (which is vulnerable to the impacts of climate change) and calculated the financial impacts. In FY March 2020, we conducted a scenario analysis for profit centers—the asset management solution business (which is part of the Financial IT Solutions business) and Consulting business—and calculated financial impacts.

TCFD scenario analysis Implementation status

	FY March 2018	FY March 2019	FY March 2020
Implementation details	Study the scenarios and identify risks/opportunities · Identifying risks and opportunities for the 2°C and 4°C scenarios	Scenario analysis for businesses vulnerable to climate change · Calculating financial impact	Scenario analysis for profit center · Calculating financial impact
Target Project	Consulting		Consulting
	Financial IT Solutions		Asset Management Solution
	Industrial IT Solutions		
	Data centers	Data centers	Report target for FY March 2021

Anticipated Impacts on Our Businesses (Opportunities and Risks)

After declaring our support for the TCFD Final Report, we established the scope of our investigations in FY March 2018, the first fiscal year. We defined and identified scenarios*3: a “2°C or lower scenario,” in which the temperature increase is kept below 2°C according to the Paris Agreement, and a “4°C scenario,” in which

no measures are implemented besides those expected at present. We identified the impacts in these scenarios on the Consulting, Financial IT Solutions, Industrial IT Solutions, and Data Center businesses.

+ Opportunity - Risk

Business Field	2°C or lower scenario	4°C scenario
Consulting	+ The demand for client corporations to make changes leading to decarbonization will increase demand for NRI's knowledge and solutions related to sustainability.	- There is the risk that intensified natural disasters envisioned in the 4°C scenario will cause stagnation of the macro economy, hurt the profitability of clients, and impact business sales.
Financial IT Solutions	+ Compared with independent system development by individual corporations, NRI's shared online services will enable significant reductions in power consumption, CO ₂ emissions, and cost. Furthermore, demand can be increased by raising the renewable energy usage rate aimed at achieving RE100.	- If the profitability of financial institutions decreases due to climate change becoming a factor in asset damage and long-term stagnation of the macro economy, there is the risk of impact on demand for provided services.
Industrial IT Solutions	+ Support for increasing the efficiency of the supply chain and distribution processes will contribute to low carbonization. The advancement of related initiatives in the future will create opportunities for increasing demand.	+ Providing cloud systems will make it possible to minimize damage in the event of a natural disaster, thus reducing the risk to clients.
Data centers	+ By FY March 2050, we seek to establish carbon-free data centers that use renewable energy for all electric power. We believe that these data centers will create increased demand in conjunction with increased environmental awareness among our clients.	+ The risk of business stoppage is reduced by considering natural disasters when selecting locations, as well as by implementing a mutual backup system using multiple data centers. This creates opportunities for increasing demand.
		- There is the risk of increased expenses such as equipment maintenance/renewal expenses and cooling expenses due to power malfunctions caused by natural disasters, and due to an increase in days on which the temperature exceeds 30°C.

Scenario Analysis for the Asset Management Solution Business

In FY2020, we conducted a scenario analysis for the asset management solution business, which is part of the Financial IT Solutions business.

[Business model analysis]

To identify risks and opportunities in the asset management solution business, we first conducted a business model analysis for the asset management solution business. The asset management solution business is broadly classified into the asset management service, investment information service, and BPO service. We surveyed the relationships between these three services and the variation factors of profit that are expected to be affected by climate

change events. The below illustration demonstrates these relationships. In the asset management service, we learned that client companies' asset balances had the largest impacts. In other words, in this business model, as client companies' asset balances increase, NRI's profit grows. As client companies' asset balances decrease, NRI's profit falls. In the investment information service, we found that the amount of information required by investors had the largest impacts.

Variation factors of profit and business for asset management firms

Variation factors of profit expected to be impacted by climate-related events

		Asset balance	Transactions	No. of clients	Investor information required	No. of funds
⊙ Large impact ○ Medium impact	Asset management service	⊙	○	○	○	○
	Investment information service			○	⊙	○
	BPO service	○	○			

[Risk and opportunity analysis]

We then conducted a risk/opportunity analysis. We surveyed impacts on our services and changes anticipated at client companies regarding six climate-related events, and analyzed whether these posed risks or opportunities for NRI. The results are shown in the following illustration.

We assumed that there would be opportunities overall as ESG disclosure and other information advances. We have also conducted interviews with the management of client companies to corroborate the expected changes.

○ Opportunity ▲ It can be both a risk and an opportunity ✕ Risk

	Climate-related event	Anticipated changes	Risks / Opportunities	Related businesses
(1)	Adoption of carbon pricing (carbon tax, etc.) and subsidies for new technology	Changes to corporate competitiveness and corporate value impacts the asset balance.	▲	Asset management service
(2)	Promoting standardization and requesting improved disclosure of ESG/climate-related information to companies	Asset management companies will have increased need for organizing corporate information due to increasing amounts of information disclosed from companies and standardization of the information to disclose.	○	Investment information service BPO service
(3)	Improve disclosure of information to asset management companies	Increased need for assistance due to improved disclosure of ESG investment and sustainable finance in operation at regulatory authorities and asset owners.	○	Asset management service Investment information service BPO service
(4)	Improve disclosure of ESG information for financial products	There is demand for explanation of ESG related items, etc., in financial products for individuals developed by asset management firms.	○	Investment information service BPO service
(5)	Increased interest in personal ESG and climate change	With increasing demand for ESG investment and impact investment among millennials and generation Z, who have a particularly high interest in environmental and social problems, there is increasing need for visualizing the environmental/social impact of asset management.	○	Asset management service
(6)	Intensifying natural disasters	Loss due to natural disasters will cause a slowdown in economic activity and a temporary drop in the asset balance.	✕	Asset management service

Natural Capital

[Calculating financial impact]

Next, we predicted how variation factors of profit will change based on the anticipated changes at client companies and calculated financial impacts for the six events. The below illustration shows the calculation methods used.

Climate related events		Method for calculating financial impact
Adoption of carbon tax	(1) Adoption of carbon pricing (carbon tax, etc.) and subsidies for new technology	Set share price variation from result of GPIF estimation, etc. We analyzed the relationship between the net total assets of client companies and how much they pay to NRI to calculate the impact of share price variation on NRI.
Improve disclosures	(2) Promoting standardization and requesting improved disclosure of ESG/climate-related information to companies	We calculated the financial impact based on the market share forecast by multiplying the service usage rate by the average budget for ESG/integrated report related consulting at companies. Calculated by multiplying the service usage rate by the budget of client companies (financial institutions).
	(3) Improve disclosure of information to asset management companies	Calculated by multiplying the service usage rate by the budget of client companies (financial institutions).
Increased interest in ESG investment	(4) Improve disclosure of ESG information for financial products	Calculated by multiplying the service usage fee of client companies (financial institutions) by the unit price for providing information on financial products.
	(5) Increased interest in personal ESG and climate change	We analyzed the relationship between the number of funds of client companies and how much they pay to NRI to calculate the impact of the related fund composition on NRI.
Intensifying natural disasters	(6) Intensifying natural disasters	Set share price variation from result of GPIF estimation and past examples. We analyzed the relationship between the net total assets of client companies and how much they pay to NRI to calculate the impact of share price variation on NRI.

Anticipated contents for "2°C or lower scenario" and "3°C to 4°C scenario"

2°C or lower scenario		3 to 4°C scenario	
<p>○ Policy (1) + technology</p> <ul style="list-style-type: none"> Adoption of carbon tax: \$100 to \$140/t-CO₂ Subsidies for new technology, etc.: Plentiful subsidies for environmental technologies <p>Large impact on business profit structure and corporate value, etc.</p>	<p>○ Policy (1) + technology</p> <ul style="list-style-type: none"> Adoption of carbon tax: \$30 to \$50/t-CO₂ Subsidies for new technology, etc.: Certain amount of subsidies for environmental technologies <p>Small impact on business profit structure and corporate value, etc.</p>		
<p>○ Policy (2)</p> <ul style="list-style-type: none"> Improve disclosure regarding ESG and climate: Requests/obligations for improved ESG disclosure increase the information disclosed by companies. Disclosure frameworks, etc., will also be standardized 	<p>○ Policy (2)</p> <ul style="list-style-type: none"> Improve disclosures regarding ESG and climate: Requests for improved disclosure regarding ESG increase the information disclosed by companies. But disclosure frameworks, etc., will not be standardized 		
<p>○ Economy/society</p> <ul style="list-style-type: none"> Increased interest in environment/society: Asset owners and individuals will increase interest in the impact of their asset management on the environment/society 	<p>○ Economy/society</p> <ul style="list-style-type: none"> Increased interest in environment/society: Asset owners and individuals will not have much increased interest in the impact of their asset management on the environment/society 		
<p>○ Natural environment</p> <ul style="list-style-type: none"> Intensifying natural disasters: Intensifying natural disasters will not change significantly from the current situation 	<p>○ Natural environment</p> <ul style="list-style-type: none"> Intensifying natural disasters: Intensifying natural disasters become apparent and changes in climate patterns become clear 		

We derived calculation methods for and calculated financial impact for each of the events based on the calculation methods in the above illustration and what we anticipated for each scenario.

For instance, regarding (1) Adoption of carbon pricing (carbon tax, etc.) and subsidies for new technology, changes to corporate competitiveness and corporate value impact the asset balance. These impacts on the asset balance also affect profit in the asset management service. Therefore, we conducted a regression analysis to find the correlation coefficient for client companies' asset balances and profit in NRI's asset management service. Assuming asset balance changes caused by the 2°C or lower scenario and the 3 to 4°C scenario, we can derive profit changes in the asset management service.

To predict stock asset balance changes in the 2°C or lower scenario and the 3 to 4°C scenario, we used the rate of fluctuation, which indicates the impacts of climate on the corporate value of the entire portfolio, from the GPIF's ESG Report released in August 2020.

For events (2) to (6), we once again derived calculation methods and calculated financial impacts.

Financial impact was expressed as profit change. The following illustration shows the financial impacts in terms of changes in earnings, summarized in four categories: adoption of a carbon tax, etc.; improved disclosure; increased interest in ESG investing; and intensifying natural disasters.

According to the illustration above, the impact of increased sales is relatively larger in the 2°C or lower scenario, while the impact of decreased sales is larger in the 3 to 4°C scenario.

Financial impact for Asset Management Solution Business

- In a 2°C or lower scenario, positive impact on sales is relatively larger, but in a 3 to 4°C scenario, negative impact on sales is larger.

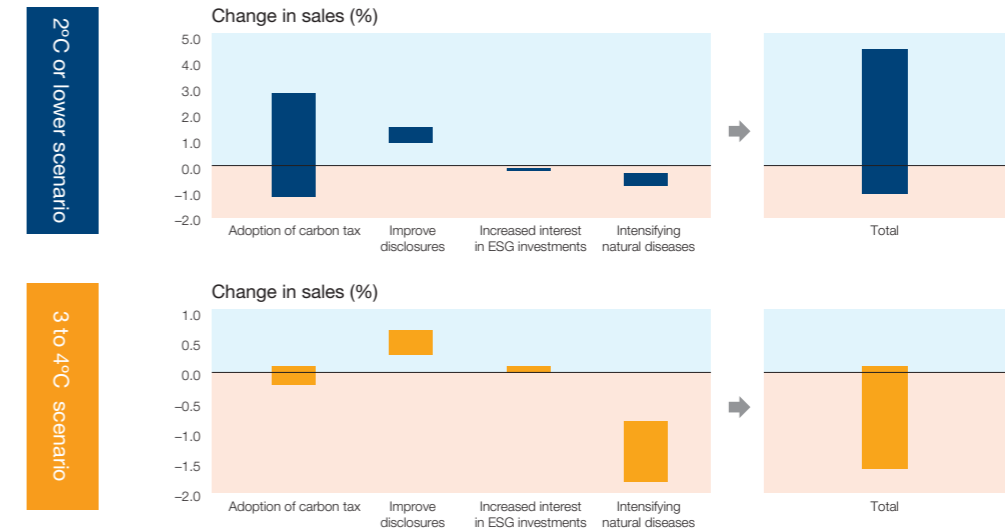

Scenario Analysis for the Consulting Business

In FY March 2020, we conducted a scenario analysis for the consulting business.

[Risk and opportunity analysis]

We conducted a risk and opportunity analysis for the consulting business. The results are shown in the illustration below.

We found that, while climate change results in increased needs for consulting business regarding sustainability, there is a high level of business risk if an economic slowdown occurs due to a failed shift to decarbonization and intensifying natural disasters.

Risks and Opportunities in the Consulting Business

- Demand for corporate assistance for adapting to climate change and shifting to a decarbonized society is expected to increase, but negative impact due to a slowdown in the macro economy is expected if the shift fails.

Climate-related events	Anticipated changes	Opportunities / Risks
Adoption of carbon pricing (carbon tax, etc.) and subsidies for new technology	Increased need for consulting due to higher necessity for strategy building and business structure reform for shifting to decarbonization	○ Opportunity
Setting terms and conditions that include climate change in the market	On the other hand, if many companies fail to shift to decarbonization in the long term, this may impact the sales of our consulting business	✗ Risk
Changes to market structure due to new environmental technologies	A slowdown in economic activity due to loss caused by natural disasters may impact the sales of our consulting business	✗ Risk
Intensifying natural disasters	On the other hand, there may be greater need for our consulting business in order to build countermeasures	○ Opportunity
Changes in weather patterns		

Natural Capital

[Opportunities in the consulting business]

We anticipated future consulting opportunities based on our current track record for consulting work regarding sustainability. The results are shown in the illustration below. We found that there would be greater consulting needs in the 2°C or lower scenario than in the 3 to 4°C scenario, and that sales would increase as well.

Opportunities in the consulting business

- With companies in a period of migrating to decarbonization, demand for related consulting is increasing due to rising interest in the sustainability of the economic community, and is expected to further increase with 2°C or lower scenario.

Sustainability-related sales in the consulting business (forecast)

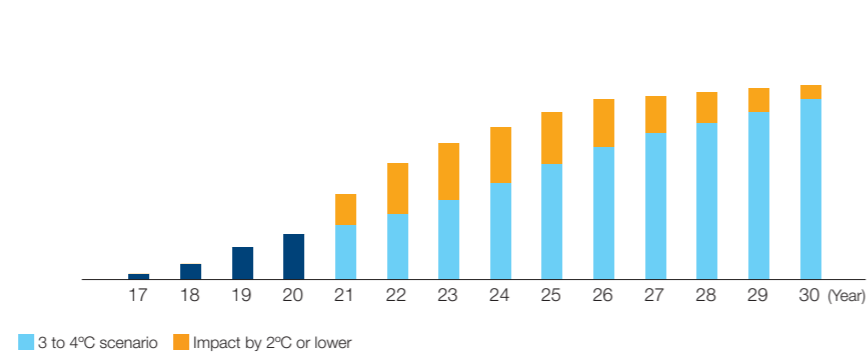

[Risks in the consulting business]

Regarding consulting risks, the economy will worsen if the global shift to decarbonization fails, causing natural disasters to intensify. Assuming that the impacts of a worsened economy would be similar to the financial crisis, we calculated that sales would decrease by 12.1%.

Risks in the Consulting Business

- We analyzed the impact of the economy worsening due to the crisis that may occur if the shift to decarbonization fails, based on past impacts
- Sales (net sales) decreased by 12.1% in FY March 2009 due to the financial crisis that year

Past impacts of major crises in the consulting business

	FY March 2008	FY March 2009	Rate of change
Actual production	¥18.12 billion	¥17.27 billion	-4.7%
Status of orders	¥32.25 billion	¥28.23 billion	-12.5%
Sales results	¥32.87 billion	¥28.88 billion	-12.1%

Expected business loss due to the economy worsening because of increased severity of natural disasters if the shift to decarbonization fails

* The above was based on the Annual Securities Report at the time, therefore the values are to be used as reference values for scenario analysis only, as there have been changes to the segments and business structure.

*1 TCFD: The Task Force on Climate-related Financial Disclosures (TCFD) was established by the Financial Stability Board, whose members include ministries of finance, financial regulatory agencies, and central bank governors from 25 major nations around the world. TCFD recommends that corporations disclose climate-related financial information, in formats such as major annual reports, so investors can make suitable investment decisions. TCFD asks that these reports disclose information on four themes about the risks that climate change poses to corporations, including governance, strategy, and risk management.

*2 ESG Briefing: The NRI Group holds its ESG Briefing so investors, analysts, and members of the media can understand our sustainability management and specific ESG-related initiatives. Refer to the website (<https://www.nri.com/en/sustainability/management/esg/2018>).

*3 Scenario: We are striving to conduct scenario analyses (analyses on how climate change could affect our business in the future) as recommend by TCFD. Regarding the 2°C or lower scenario, the NRI Group uses the Sustainable Development Scenario in the World Energy Outlook 2018 released by the International Energy Agency (IEA), and Representative Concentration Pathway (RCP) 2.6 (low, stable scenario) from the Intergovernmental Panel on Climate Change (IPCC). We also use the IPCC Special Report on the impacts of global warming of 1.5°C (SR1.5) in a supplementary manner. For the 4°C scenario, we use the IPCC's RCP 8.5 (high reference scenario).

Participation in Initiatives



May 2017
United Nations Global Compact
NRI is active both in Japan and on a global scale. To continue to gain trust from society and meet expectations, NRI endorsed the United Nations Global Compact (UNGC) and announced its participation in May 2017.

June 2018
Japan Climate Initiative



July 2018
Task Force on Climate-related Financial Disclosures



September 2018
Science Based Targets initiative



January 2019
World Business Council for Sustainable Development (WBCSD)



February 2019
Renewable Electricity 100%



May 2020
Business Ambition for 1.5°C



Status of Inclusion at Equities in ESG Stock Indices

NRI is included in the equities used for the main ESG stock indexes.

Dow Jones Sustainability World Index
Included for three consecutive years from 2018

Dow Jones Sustainability Asia Pacific Index
Included for five consecutive years from 2016



MSCI ESG Leaders Indexes*
Name of indexes changed from MSCI Global Sustainability Indexes
Included for five consecutive years from 2016



FTSE4Good Index Series
Included for fifteen consecutive years from 2006



MSCI Japan ESG Select Leaders Index*

2020 CONSTITUENT MSCI JAPAN ESG SELECT LEADERS INDEX

MSCI Japan Empowering Women Index*

2020 CONSTITUENT MSCI JAPAN EMPOWERING WOMEN INDEX (WIN)

FTSE Blossom Japan Index



S&P/JPX Carbon Efficient Index



* THE INCLUSION OF Nomura Research Institute, Ltd IN ANY MSCI INDEX, AND THE USE OF MSCI LOGOS, TRADEMARKS, SERVICE MARKS OR INDEX NAMES HEREIN, DO NOT CONSTITUTE A SPONSORSHIP, ENDORSEMENT OR PROMOTION OF Nomura Research Institute, Ltd BY MSCI OR ANY OF ITS AFFILIATES. THE MSCI INDEXES ARE THE EXCLUSIVE PROPERTY OF MSCI. MSCI AND THE MSCI INDEX NAMES AND LOGOS ARE TRADEMARKS OR SERVICE MARKS OF MSCI OR ITS AFFILIATES.

Governance

NRI's Corporate Governance

NRI works to enhance corporate governance in accordance with the basic approach outlined below, based on the recognition that corporate governance consists of mechanisms for transparent, fair, timely, and accurate decision-making based on the perspective of stakeholders, including society, customers, employees, business partners, and shareholders.

NRI have made the NRI Corporate Governance Guidelines public to outline our basic approach and action policy regarding corporate governance.

 [NRI Corporate Governance Guidelines](https://www.nri.com/-/media/Corporate/en/Files/PDF/company/governance/guideline_e_02.pdf)
https://www.nri.com/-/media/Corporate/en/Files/PDF/company/governance/guideline_e_02.pdf

The Basic Approach to Corporate Governance

(1) Cooperation with stakeholders

NRI respects the interests of stakeholders and cooperates with them in an appropriate manner. In particular, with regard to shareholders, NRI takes the proper measures so that rights are substantially secured, in addition to ensuring substantial equality.

(2) Information disclosure and communication

NRI discloses information as stipulated by laws and by the regulations of the Tokyo Stock Exchange, and information that assists its stakeholders in understanding NRI and its operations properly, in a timely, accurate, and fair manner, to secure transparency as well as to engage in constructive dialogue with its shareholders.

(3) Corporate governance system

NRI is strengthening its management monitoring functions based on the Audit & Supervisory Board System through the appointment of Independent Directors and Independent Audit & Supervisory Board Members, as well as the establishment of bodies that are mainly composed of Independent Directors appointed to advise the Board of Directors.

Main corporate governance efforts since 2001

2001	<ul style="list-style-type: none"> Formulated the NRI Group's corporate philosophy Listed on the Tokyo Stock Exchange (Section 1)
2002	<ul style="list-style-type: none"> Introduced an executive officer system to assist in separating management and execution functions Reduced the number of members of the Board of Directors to within 20 and also appointed Independent Outside Directors Increased the number of Outside Audit & Supervisory Board Members to strengthen their auditing functions
2003	<ul style="list-style-type: none"> Formulated the NRI Group's Ethical Code (revised to the NRI Group's Code of Business Principles on 2010) and the NRI Group Employees' Code of Business Conduct
2005	<ul style="list-style-type: none"> Established the Compensation Committee comprising outside experts to enhance transparency in regard to executive compensation
2006	<ul style="list-style-type: none"> Reduced the number of members of the Board to 15 or less
2008	<ul style="list-style-type: none"> Initial release of the Long-term Management Vision: Vision2015 Took part in an electronic voting platform for institutional investors as part of efforts to maximize opportunities for shareholders to exercise their voting rights
2010	<ul style="list-style-type: none"> Appointed non-executive director to chair the Board of Directors to separate supervisory and execution functions
2012	<ul style="list-style-type: none"> Newly established the Integrated Risk Management Supervisory Department to appropriately manage any risk that may arise in the course of business execution
2015	<ul style="list-style-type: none"> Increased the number of Independent Outside Directors from two to three Established the Independent Executives Meeting consisting of Independent Outside Directors and Independent Outside Audit & Supervisory Board Members Formulated the NRI Corporate Governance Guidelines Revised the NRI Group's Code of Business Principles completely
2016	<ul style="list-style-type: none"> Initial release of the Medium-Term Management Plan (From FY March 2017 to FY March 2019) Implemented the evaluations of the Board of Directors' effectiveness
2017	<ul style="list-style-type: none"> Newly established the Nomination Committee, comprising mainly Independent Directors Changed the main members of the Compensation Committee from outside experts to Independent Directors
2018	<ul style="list-style-type: none"> Introduction of Restricted Stock Compensation Plan as a medium- to long-term incentive for Members of the Board

Corporate governance structure

(As of July 1, 2021)

For the Board of Directors and the Audit & Supervisory Board, see P.82-83

For the Internal Controls, Corporate Ethics, and Compliance, see P.88-89

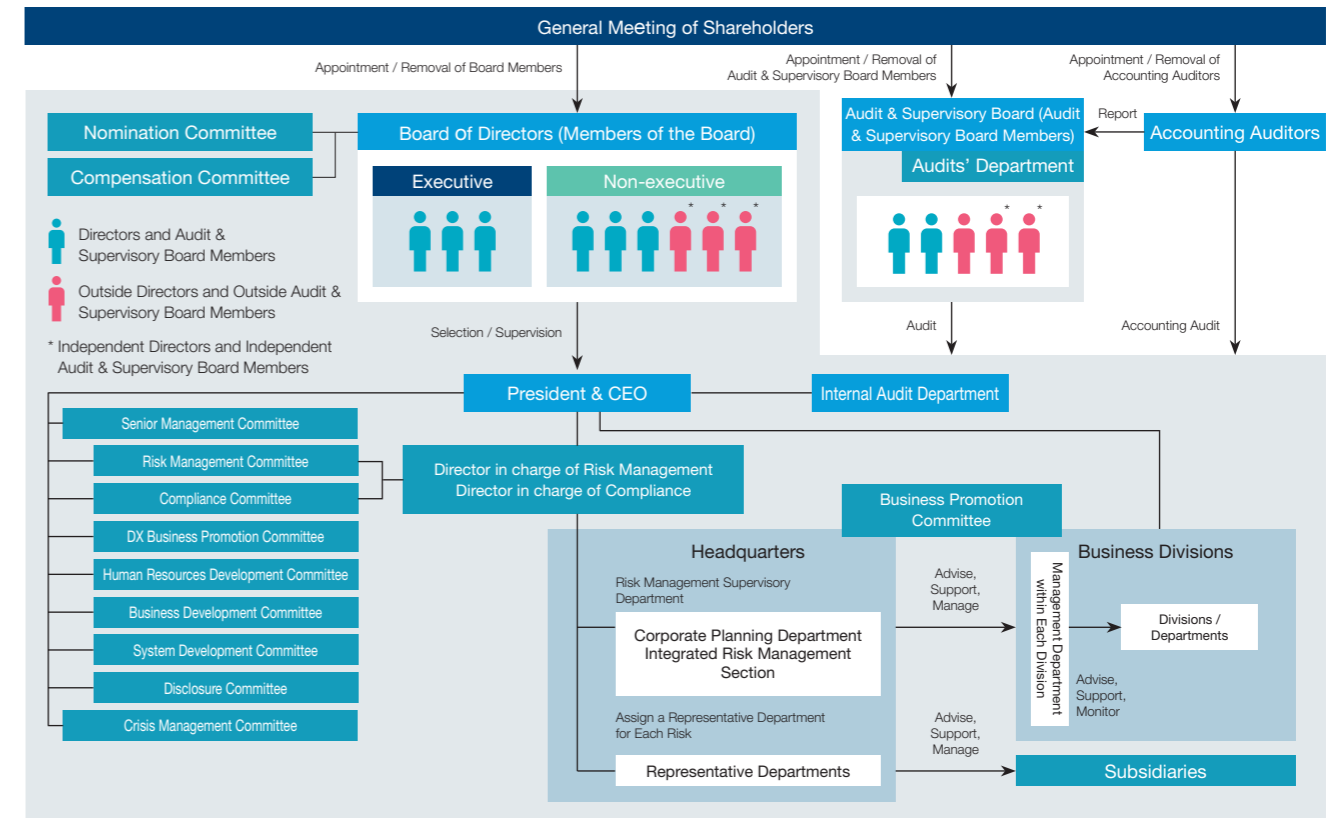

Roles and activities of committees

Name of the organization	Objective and authority	Head of the organization
Board of Directors	Conduct the fundamental decision-making that is the basis for the Company's business execution and oversee the execution of duties by Members of the Board.	Yasuo Fukami Vice Chairman, Member of the Board
Audit & Supervisory Board	Discuss and decide auditing policies and other important matters related to auditing and formulate and express audit opinions.	Takuhito Sakata Audit & Supervisory Board Member
Nomination Committee	Mainly composed of Independent Directors, the Committee deliberates on executive appointment matters related to Directors, Audit & Supervisory Board Members, the CEO, and other Board Members, from the standpoint of fairness and transparency.	Yasuo Fukami Vice Chairman, Member of the Board
Compensation Committee	Mainly comprising Independent Directors, the Committee deliberates on the system and standards of executive compensation from the standpoint of fairness and transparency.	Yasuo Fukami Vice Chairman, Member of the Board
Senior Management Committee	The Committee meets in principle to deliberate on important issues involving corporate management in order to achieve consistent business execution and decision-making.	Shingo Konomoto President & CEO, Representative Director, Member of the Board
Integrated Risk Management Committee	Based on instructions given by the President & CEO, the Committee deliberates on important issues concerning risk management, including system failure, information security, and business continuity.	Hidenori Anzai Representative Director, Member of the Board, Senior Executive Managing Director
Compliance Committee	The Committee deliberates on the issues concerning the promotion of ethical and compliance management covering the improvement of structures to comply with corporate ethics and laws and the prevention of violation reoccurrences, based on instructions given by the President & CEO.	Hidenori Anzai Representative Director, Member of the Board, Senior Executive Managing Director
DX Business Promotion Committee	Based on the instructions given by the President & CEO, the Committee deliberates on important issues concerning promotion of the digital transformation (DX) business.	Hiroshi Masutani Senior Executive Managing Director
Human Resources Development Committee	The Committee deliberates on important issues concerning ability development and training of employees, based on instructions given by the President & CEO.	Hidenori Anzai Representative Director, Member of the Board, Senior Executive Managing Director
Business Development Committee	The Committee deliberates on important issues concerning investments in research and development, planned businesses, and investments, such as the acquisition of securities, based on instructions given by the President & CEO.	Yoshihiko Sunaga Senior Corporate Managing Director
Systems Development Committee	The Committee deliberates on important issues concerning proposals and quotations to clients, as well as on their development and release of IT solution-related systems, based on instructions given by the President & CEO.	Susumu Nishimoto Senior Corporate Managing Director
Disclosure Committee	The Committee deliberates on important issues concerning the disclosure of Annual Securities Report and other documents, based on instructions given by the President & CEO.	Yoshihiko Sunaga Senior Corporate Managing Director
Crisis Management Committee	Based on instructions given by the President & CEO, the Committee will promptly develop and support systems at the time of a crisis, including natural disasters, infectious diseases, system failure, and information security emergencies.	Hidenori Anzai Representative Director, Member of the Board, Senior Executive Managing Director
Business Promotion Committee	The Committee involves administrative departments from the headquarters and management departments within business divisions and seeks to establish highly effective and efficient internal controls.	Yoshihiko Sunaga Senior Corporate Managing Director

Governance

System of the Board of Directors and the Audit & Supervisory Board

NRI has established a structure to further enhance corporate governance while effectively using the functions of Audit & Supervisory Board Members and the Audit & Supervisory Board as a company with an Audit & Supervisory Board.

NRI has delegated to considerable authority and responsibility for business execution to Senior Managing Directors and other Directors. The Board of Directors is exclusively responsible for fundamental decision-making that is the basis for the Company's business execution and for overseeing the execution of duties by Members of the Board. The Audit & Supervisory Board Members and Audit & Supervisory Board oversee the execution of duties by Members of the Board.

Senior Managing Directors and Managing Directors appointed through a resolution by the Board of Directors are responsible for the execution of business based on policies adopted by the Board. NRI holds a Senior Management Committee attended by Representative Directors and Senior Managing Directors once a week and deliberates on the important issues involving corporate management in order to coordinate our business activities and build consensus in executing business operations.

Structure of the Board of Directors

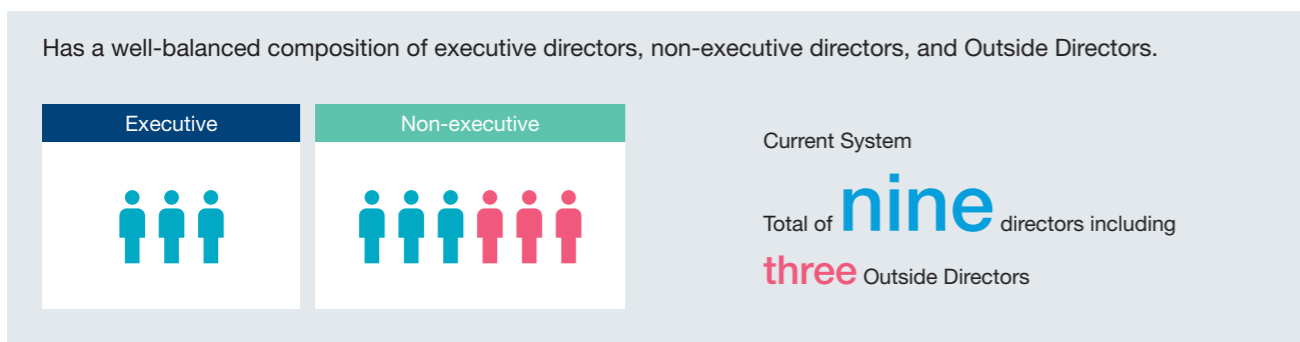

The Company elects three Independent Directors in principle, or no less than two Independent Directors.

The Board of Directors includes no more than 15 Members of the Board, taking into consideration of the balance and the diversity of various factors, including experience in and knowledge of the Company's businesses, corporate management, IT technology, and corporate finances.

Advisory committees for the Board of Directors

NRI has established the following two advisory committees mainly composed of Independent Directors.

- Nomination Committee: Nomination Committee deliberates on executive appointment matters related to Directors, Audit & Supervisory Board Members, the CEO, and other Board Members
- Compensation Committee: a body to advise the Board of Directors on executive compensation

Structure of the Audit & Supervisory Board

- To ensure independence, more than half are Outside Audit & Supervisory Board Members.
- Currently, there are five Audit & Supervisory Board Members, including three Outside Audit & Supervisory Board Members.

Two or more Independent, Outside Audit & Supervisory Board Members are appointed.

One or more persons with substantial knowledge regarding finance and accounting are appointed as Audit & Supervisory Board Members.

To ensure that audits are effectively conducted by the Audit & Supervisory Board Members, the Audits' Department has been established to support the work of the Audit & Supervisory Board Members.

Members of the Board (As of July 1, 2021)

Name (Date of birth)	Current positions	Executive/ Outside/ Independent	Terms of office	Attendance (Year ended March 2021)	Reason for Appointment
Shingo Konomoto (February 11, 1960)	President & CEO, Representative Director, Member of the Board	Executive	6 years	Board of Directors Attended 14 of 14 meetings	He has been responsible for the management of the NRI Group since 2016 as President & CEO, and possesses abundant experience and achievements related to NRI's management. Furthermore, he formulated and is promoting the Long-term Management Vision "Vision2022" and the Medium-Term Management Plan for achievement of the Vision. NRI has appointed him with the expectation that the experience and knowledge nurtured through his career can be utilized in the management of NRI.
Yasuo Fukami (August 12, 1960)	Vice Chairman, Member of the Board	Non-executive	2 years	Board of Directors Attended 14 of 14 meetings	In addition to experience in global business in Asia and Europe, he possesses a broad range of experience and achievements in the execution of business in the financial IT solutions and industrial IT solutions business areas as well as in corporate administration. Furthermore, as Chairperson of the Compensation Committee, he is endeavoring to ensure objectivity and fairness in the determination, etc., of director compensations. NRI has appointed him with the expectation that the experience and knowledge nurtured through his career can be utilized in the supervision of the management of NRI.
Hironori Momose (September 15, 1961)	Vice Chairman, Member of the Board	Non-executive	2 years	Board of Directors Attended 14 of 14 meetings	He has successively assumed various posts at Nomura Securities Co., Ltd., including that of Executive Officer and Senior Executive Managing Director, and possesses long-standing experience in the securities industry, which is one of NRI's major business areas. He was appointed with the expectation that he will utilize his experience and understanding gained through his career, in the supervision of the management of NRI.
Hidenori Anzai (November 9, 1964)	Senior Executive Managing Director, Representative Director, Member of the Board	Executive	Newly Appointed	—	He possesses a broad range of experience and achievements in the execution of business in the financial IT solutions, industrial IT solutions, and IT infrastructure solutions business areas as well as in corporate administration. NRI has appointed him with the expectation that the experience and understanding gained through his career can be utilized in the management of NRI.
Ken Ebato (October 28, 1963)	Senior Executive Managing Director, Member of the Board	Executive	Newly Appointed	—	He possesses a wide range of experience in the business execution and achievements in the areas of financial IT solutions and industrial IT solutions. NRI has appointed him with the expectation that the experience and understanding gained through his career can be utilized in the management of NRI.
Hiroshi Funakura (July 10, 1963)	Member of the Board	Non-executive	1 year	(after assuming the post on June 18, 2020) Board of Directors Attended 11 of 11 meetings	He has long-standing experience in business execution and achievements in the areas of financial IT solutions. NRI has appointed him with the expectation that the experience and knowledge nurtured through his career can be utilized in the management of NRI.
Hideaki Omiya (July 25, 1946)	Member of the Board	Non-executive Outside Independent	3 years	Board of Directors Attended 13 of 14 meetings	For many years, he has been involved in the management of Mitsubishi Heavy Industries, Ltd., and has worked for the growth of the NRI Group and related industries. Utilizing the abundant experience and high level of insight cultivated through his career, he has contributed to enhancing the Company's management supervision function; for example, he has expressed a wide range of opinions regarding overall management at the Company's Board of Directors, Nomination Committee, and Compensation Committee. NRI requests his election so that he can continue to utilize his abundant experience and outstanding insight to supervise management of NRI from an objective standpoint in the Board of Directors, Nomination Committee, and Compensation Committee.
Shinoi Sakata (March 31, 1957)	Member of the Board	Non-executive Outside Independent	1 year	(after assuming the post on June 18, 2020) Board of Directors Attended 11 of 11 meetings	She, as a researcher and a person with responsibilities in the area of safety in the chemical industry, has been involved in the activities of evaluating technology strategies of corporations from the perspective of sustainability for many years. Utilizing the abundant experience and high level of insight cultivated through her career, she has contributed to enhancing the Company's management supervision function, such as giving opinions on securing sustainability, ensuring diversity, and developing human resources, at the Board of Directors, Nomination Committee, and Compensation Committee of the Company. NRI requests her election so that she can continue to utilize the abundant experience and excellent understanding gained throughout her career to supervise management of the Company from an objective standpoint in the Board of Directors, Nomination Committee, and Compensation Committee.
Tetsuji Ohashi (March 23, 1954)	Member of the Board	Non-executive Outside Independent	Newly Appointed	—	For many years, he has been involved in the management of Komatsu Ltd. and has promoted growth through innovation at Komatsu Ltd.; for example, such as promoting the digitization of construction sites. NRI requests his reelection so that he can utilize his abundant experience and excellent understanding gained throughout his career in the supervision of the management of NRI from an objective standpoint in the Board of Directors, Nomination Committee, and Compensation Committee.

Audit & Supervisory Board Members (As of July 1, 2021)

Name (Date of birth)	Current positions	Outside/ Independent	Terms of office	Attendance (Year ended March 2021)	Reason for Appointment
Takuhiro Sakata (November 20, 1961)	Audit & Supervisory Board Member (full-time)	—	1 year	(after assuming the post on June 18, 2020) Board of Directors Attended 11 of 11 meetings Audit and Supervisory Committee Attended 14 of 14 meetings	He possesses a broad range of experience and achievements in the execution of business in the areas of industrial IT solutions and IT platform services, as well as the human resources development function of NRI group. NRI has appointed him with the expectation that the experience and knowledge nurtured through his career can be utilized in the audit of the execution of duties by NRI directors.
Kohei Sato (April 18, 1961)	Audit & Supervisory Board Member (full-time)	Outside	3 years	Board of Directors Attended 14 of 14 meetings Audit and Supervisory Committee Attended 18 of 18 meetings	He has long-standing experience in the securities industry, which is one of NRI's major business areas. NRI requests his election as Outside Audit & Supervisory Board Member to utilize his abundant experience and excellent understanding gained throughout his career, in the auditing of the execution of NRI's Members of the Board from an objective standpoint.
Motoya Nishimura (July 23, 1962)	Audit & Supervisory Board Member (full-time)	—	2 years	Board of Directors Attended 14 of 14 meetings Audit and Supervisory Committee Attended 18 of 18 meetings	He possesses a broad range of experience and achievements in the execution of business in the consulting and financial IT solutions business areas as well as in corporate administration. NRI has appointed him with the expectation that the experience and knowledge nurtured through his career can be utilized in the audit of the execution of duties by NRI directors.
Kiyotaka Yamazaki (April 4, 1953)	Audit & Supervisory Board Member	Outside Independent	7 years	Board of Directors Attended 14 of 14 meetings Audit and Supervisory Committee Attended 18 of 18 meetings	He serves as Managing Partner of an audit corporation and has long-standing experience as a certified public accountant. Although he has not been involved in the management of a company in a capacity other than Outside Audit & Supervisory Board Member, NRI requests his reelection as Outside Audit & Supervisory Board Member to utilize his abundant experience and excellent understanding concerning finance and accounting, which he has gained through his career, in the auditing of the execution of NRI's Members of the Board from an objective standpoint.
Kenkichi Kosakai (August 9, 1953)	Audit & Supervisory Board Member	Outside Independent	Newly Appointed	—	For many years, he has been involved in the management of Mitsubishi Chemical Holdings Corporation and other Mitsubishi Chemical Holdings Corporation group companies. He possesses work experience in the accounting and finance department, and experience as CFO NRI has appointed him with the expectation that he will utilize his abundant experience and excellent understanding concerning corporate management gained throughout his career, in the auditing of the execution of NRI's Members of the Board from an objective standpoint.

Governance

Compensation for Members of the Board and Audit & Supervisory Board Members

Compensation System for Members of the Board

- In the interest of enhancing business results, the compensation system emphasizes connections to business performance.
- Emphasis is placed on bonuses and stock-based compensations so as to create a compensation system that is highly linked to performance.

The standards employed by the compensation system have been set with reference to market standards and trends and other factors, with the goal of establishing standards appropriate for a leading company in the information services industry.

To improve transparency of directors' compensation and others, NRI has established the Compensation Committee, comprising mainly Independent Directors, as an advisory body to the Board of Directors. The committee deliberates on the system and standards of executive compensation from the standpoint of fairness and transparency. Using the results of the committee's inquiries, the Board of Directors sets policies for the determination of compensation for Members of the Board and other matters.

Compensation for the Members of the Board of NRI comprises three categories (a. basic compensation, b. bonuses and c. stock-based compensation).

Outside Members of the Board do not receive a b. bonus or c. stock-based compensation.

The maximum compensation total

Total Compensation ¥1,000 million*1			
[Fixed compensation] Basic compensation	[Performance-based compensation]		
	[Short-term performance-based compensation] Bonuses	[Medium- to long-term performance-based compensation] Stock-based compensation (restricted stock-based compensation)	
		¥400 million*2	
Basic compensation consists of fixed pay (basic pay and position pay), which is compensation based on each Member of the Board's post.	Bonuses are positioned as a short-term incentive. They reflect performance in the relevant fiscal year and their determination takes into account differences in posts and positions.	Restricted stock compensation (financial compensation used as investment assets for the acquisition of shares with restriction on transfer compensation) as stock-based compensation is provided in order to give incentives aimed at sustainable improvements in the Company's corporate value and to promote the sharing of value with shareholders through share ownership.	
		The number of shares allocated is determined in accordance with executive positions. Note that, based on the Stock Ownership Guidelines for Executive Officers, Members of the Board are expected to hold more than a certain number of shares of NRI's stock, in accordance with their respective positions.	
		Stock-based compensation as long-term incentives	Stock-based compensation as medium-term incentives
		¥120 million*2	¥280 million*2
		It is positioned as a long-term incentive aimed at promotion of the sharing of value with shareholders through share ownership and sustainable improvements in the Company's corporate value.	It is positioned as a medium-term incentive aimed at improvements in the Company's medium-term results and share price as represented in the Medium-Term Management Plan.
		The transfer restriction term is from the day of allotment to the day of retirement as an officer, etc., of NRI or its subsidiary.	The transfer restriction term is from the day of allotment and lasts between three and five years thereafter.

*1 This shall not include employee salaries of Members of the Board who concurrently serve as employees.

*2 Monetary compensation claims provided for granting restricted stock to Eligible Members.

Emphasis is placed on bonuses and stock-based compensations so as to create a compensation system that is highly linked to performance. The approximate ratio of constituent elements of the compensations of directors, etc., in FY March 2021 is as follows. If basic compensation is equalized to "1", the bonus is "0.7" and stock-based compensation is "1.5". If fixed compensation is "1", performance-based compensation is "2.2".

Compensation Ratio for Director Compensation (FY March 2021)

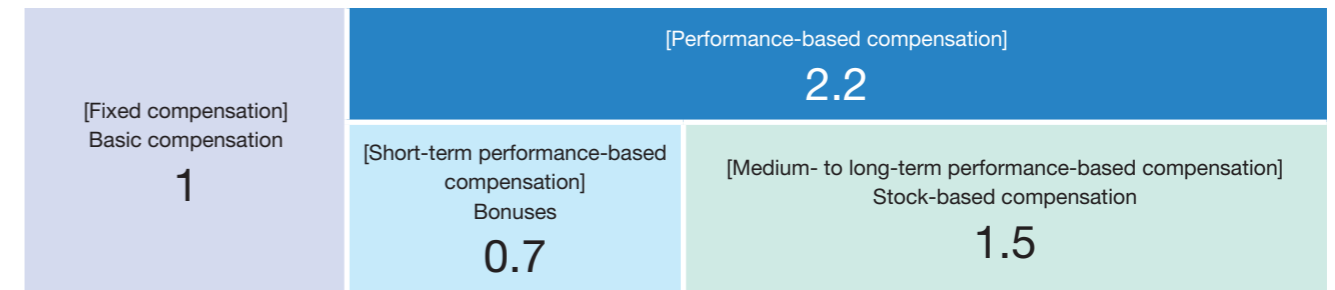

Note:

1. Calculations are based on the Board of Directors average for FY March 2021 (excluding Outside Directors and Directors who retired or assumed their post during the period).

2. Stock-based compensations herein are the total amount of monetary compensation receivables that would be contributed in kind in exchange for the shares with transfer restrictions.

Clawback System, etc.

If it becomes necessary to make corrections, etc., to figures in the financial statements that served as the basis for calculating bonuses paid within the past three years, we have implemented a system that makes it possible to request the return of all or a portion of the bonus (clawback system). Furthermore, if persons granted restricted stock under the Restricted Stock Compensation Plan are deemed by the Board of Directors to be in violation of laws, regulations, or internal rules, or to have engaged in nonconforming behavior that constitutes a violation thereof, the agreement on the allocation of restricted stock includes a clause (malus clause) that enables us to freely acquire all granted shares.

The target of the clawback system is Members of the Board (excluding Outside Directors), Senior Managing Directors, Managing Directors, and Executive Fellows.

Process for Determining Compensation, etc., for Members of the Board

Regarding compensation, etc., for Members of the Board, the Compensation Committee, which functions as an advisory body to the Board of Directors and is composed mainly of Independent Directors, provides advice on the system and level of compensation, the content of individual compensation, and related decision-making policies and procedures. Based on the results, the Board of Directors decides on the policy of compensation, for Members of the Board and the contents of individual compensation, etc.

The amount of basic compensation, among compensation paid to individual Members of the Board, is confirmed by the Compensation Committee according to the tables for each position as defined in decision policy for compensation, of Members of the Board. The final decision on the amount of basic compensation, etc., is entrusted to the Chairman and President & CEO, Shingo Konomoto.

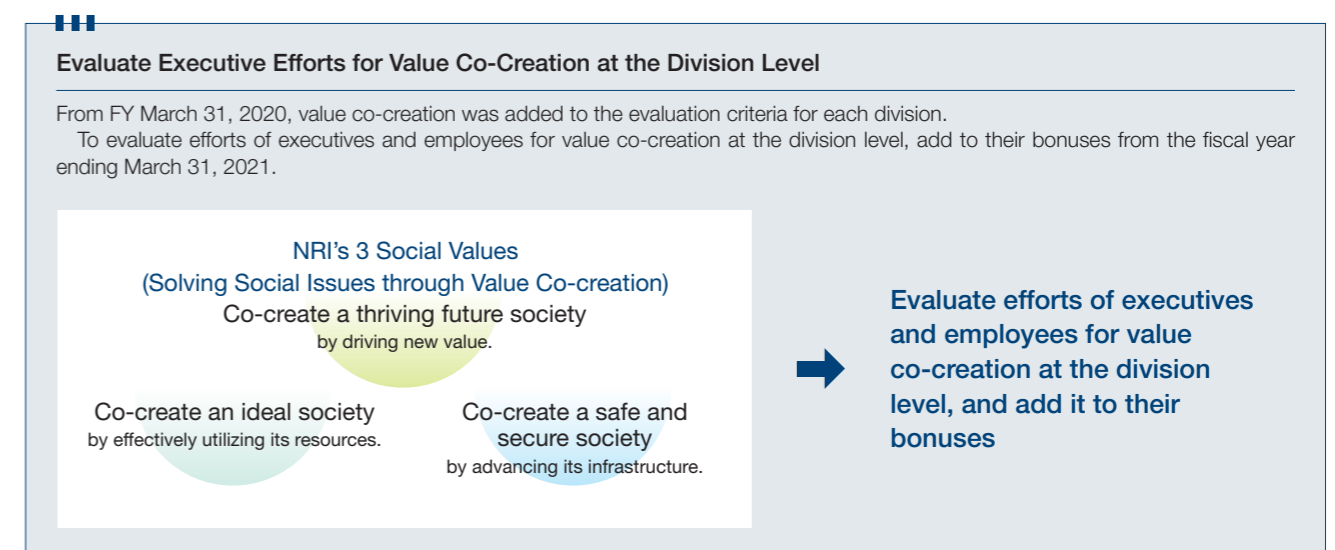

Governance

Compensation for Members of the Audit & Supervisory Board Members

Policies for the determination of compensation for Audit & Supervisory Board Members and other matters are set through discussions among the Audit & Supervisory Board Members.

The role of the Audit & Supervisory Board Members is to audit the Members of the Board in the performance of their duties and to do so from an independent standpoint. However, given that the full-time Audit & Supervisory Board Members share with the Members of the Board the objective of realizing sound, sustainable growth for NRI, their compensation, in addition to a fixed amount, includes a variable portion that changes in accordance with our business performance.

Levels of compensation have been set based on the need to secure human resources capable of playing important roles in the establishment and operation of effective corporate governance.

The maximum compensation total for Audit & Supervisory Board Members: ¥250 million per annum

Basic compensation	Basic compensation consists of fixed pay based on each Audit & Supervisory Board Member's career, knowledge, responsibilities.
Bonuses	Bonuses are only paid to the full-time Audit & Supervisory Board Members, and it is based on our business performance during the current fiscal year.

(Note) In regard to Audit & Supervisory Board Members, stock-based compensation is not issued.

Executive Compensation Amounts

Executive compensation for FY March 2021 is as follows.

Category	Total compensation (millions of yen)	Compensation by type (millions of yen)					Other	No. of eligible individuals (persons)
		Fixed compensation	Performance-based compensation					
		Basic compensation	Bonuses	Stock options	Restricted stock-based compensation	Total		
Members of the Board (Excluding Outside Members of the Board)	620	228	164	5	219	390	1	7
Audit & Supervisory Board Members (Excluding Outside Audit & Supervisory Board Members)	107	58	27	0	20	47	2	3
Outside Members of the Board and Outside Audit & Supervisory Board Members	110	96	13	—	—	13	0	7

- Notes:
- The above includes two Members of the Board, including one Outside Members of the Board, and one Audit & Supervisory Board Member who retired at the conclusion of the 55th Ordinary General Meeting of Shareholders held on June 18, 2020.
 - For stock options, the total fair value of subscription rights to shares has been converted to costs equally in accordance with the term of service from the day of the allotment of subscription rights to shares to the commencement date of the exercise period. In regard to those granted prior to FY March 2018, the amount converted to costs for FY March 2021, is shown. Furthermore, the stock options for Audit & Supervisory Board Members are those granted before they assumed their post.
 - For restricted stock-based compensations, the total amount of monetary compensation receivables that would be contributed in kind in exchange for the shares with transfer restrictions has been converted equally in accordance with the term of service from the day of the allotment of shares with transfer restrictions to the day of the lifting of transfer restrictions. The amount posted as expenses in FY March 2021 is shown.
 - Because the amounts of the "stock option" and "restricted stock-based compensations" of Notes 2 and 3 above posted as expenses are equalized in accordance with respective terms of service, each ratio of the constituent elements of the above compensations differ from the ratio of constituent elements of Director compensations, etc., shown on the page 85.
 - "Other" refers to contributions to the defined contribution pension plan and insurance premiums for casualty insurance.

Evaluations of the Board of Directors' Effectiveness (FY March 2021)

We implemented evaluations of the Board of Directors' effectiveness for FY March 2021. The following is an overview of the evaluation based on the results of a questionnaire targeting all Directors and Audit & Supervisory Board Members, exchange of views with Independent Directors, and deliberations at meetings of the Board of Directors. We continue to work toward improving the effectiveness of the Board of Directors in light of this analysis/evaluation.

Results	Item	Details
Results	Composition and Status of Operation of the Board of Directors	<ul style="list-style-type: none"> Active explanation of opinions and presentation of recommendations from Outside Directors and other open and constructive discussions and exchanges of views are carried out by the Board of Directors as a whole. A well-balanced composition ratio of executive directors, non-executive directors, Independent Outside Directors and the diversity of their experience are being maintained, and a structure to ensure appropriate decision-making and oversight is in place.
	Management Strategy	<ul style="list-style-type: none"> Discussion and exchange of views regarding DX strategy and global strategy, which are business strategies based on the Medium-Term Management Plan, are being implemented continuously and appropriately in conjunction with discussion of the status of progress of the Plan.
	Internal Control/Risk Management/Group Governance	<ul style="list-style-type: none"> In conjunction with the increase in the number of Group companies in Japan and overseas, the current state of Group governance and related issues are shared, and discussions and exchange of views regarding the orientation of efforts in the future are being conducted appropriately. In regard to internal control and risk management, reports and discussion related to the creation and operation of internal control for each risk are continuing.
	Committee	<ul style="list-style-type: none"> In the Nomination Committee and the Compensation Committee, discussions and exchange of views related to the president & CEO succession plan, the director candidate selection and development process, and the method of determining directors' compensation, etc., are being conducted appropriately, and while being arbitrarily appointed committees, they are functioning effectively.
Challenges for further effectiveness	Efforts in Light of Effectiveness Evaluations	<ul style="list-style-type: none"> The topics of discussion by the Board of Directors are set in advance in order to enhance further discussions related to promotion of the strategy defined in the NRI Group's Medium-Term Management Plan (2019-2022) and Group governance that were issues for the fiscal year ended March 2021, and discussions are carried out according to plan. These and other improvements in light of the results of past evaluations are being implemented.
	Challenges for further effectiveness	<ul style="list-style-type: none"> Continued discussion of the ideal nature of Board of Directors composition and diversity in light of the status of business and management strategy in the future Enhancement of discussions of the ideal nature of governance from the perspective of Group management in conjunction with expanded scale after sorting out the positioning and function of each company within the Group

Message from the Outside Member of the Board



As a corporation that operates an information system serving as lifestyle infrastructure, I will support the diversification and sophistication of human resources utilization.

Shinoi Sakata
Member of the Board

Steady Promotion of the Medium-Term Management Plan

NRI is steadily achieving the goals set forth in our Medium-Term Management Plan, such as globalization and DX strategy. We have also acquired know-how that is effective on a global scale. For example, NRI has acquired Australia's largest IT testing company, Planit, which specializes in software quality*. Reliability is the most important factor in the development and operation of IT systems. There is great meaning in possessing both Japanese know-how and overseas know-how in terms of software reliability.

NRI's strengths in supporting the steady achievement of plans are its resolute and sincere attitude toward corporate culture and the depth of its human resources in both consulting and IT. Additionally, as a corporation that leads digital transformation (DX), NRI expects to continue to enhance our unconventional free thinking and break-through ability in promoting innovation.

* A service that verifies whether the designed/developed systems and applications operate according to the specifications.

Highly Effective Board of Directors

The NRI Board of Directors is able to engage in open and frank discussion with executives. One basis for meaningful discussion is that executives provide detailed background information including past questions and answers. Executives provide detailed explanations until directors are fully satisfied, thus enabling the Board of Directors to obtain an in-depth understanding of agenda items. This leads to positive discussion.

Furthermore, I feel that skills and achievements are accurately evaluated during the selection of executive human resources. NRI is expected to grow further as a corporation, including overseas expansion. Accordingly, it will be necessary to increase the sophistication of our system for selecting executive human resources as we expand the size of our corporation.

Expectations for Sustainability Management

As an initiative for sustainability management, NRI is working to solve social issues through value co-creation. These goals are integrated into NRI's businesses. Depending on the industry, there may be conflicts between initiatives for sustainability management and business. However, at NRI, our work is value co-creation with clients and contributes to solving social issues. In this way, I am very happy to be able to explain how sustainability management is directly linked to our business. It is important for all executives and employees at NRI to understand this concept.

Initiatives for diversity and inclusion aim to maximize the abilities of all executives and employees, without regard for gender. I believe that the further performance of female employees will contribute to the development of the NRI Group. Based on my experience at the company where I served as an executive, I will also contribute to increasing the diversity of NRI from the standpoint of a female Outside Director.

Governance

Internal Controls, Corporate Ethics, and Compliance

Internal Control System

NRI has established a basic policy for building an internal control system, while appointing a director in charge of risk management and setting up a department for supervising risk management.

In addition, the Integrated Risk Management Committee meets to check the company-wide internal control status as appropriate. The Business Promotion Committee, which all business divisions and group companies attend, also works to ensure that the internal control system is established.

 **Basic policy for building an internal control system (Japanese)**
<https://www.nri.com/jp/company/internal>

Risk Management PDCA Cycle

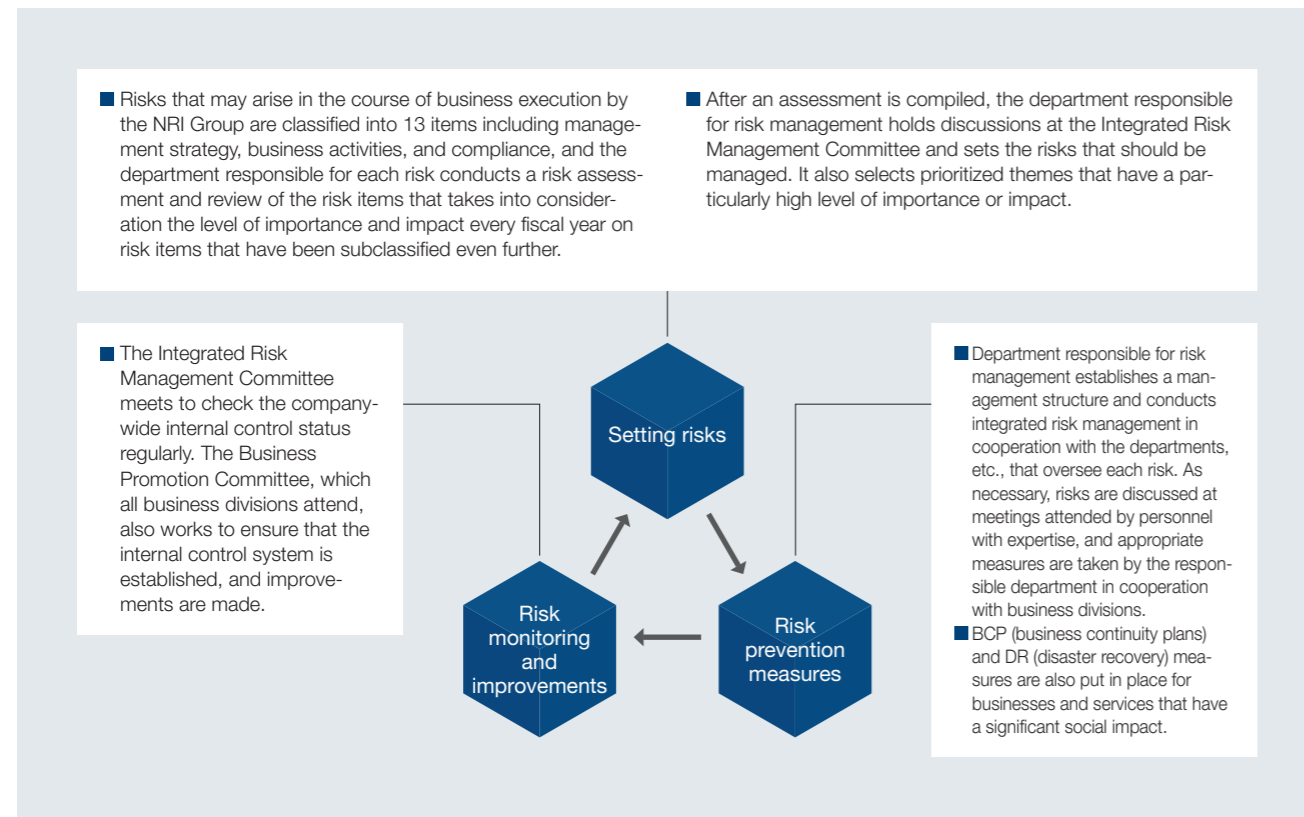

Priority themes for FY March 2022

- I Continue proper management of quality risks for systems in operation
- II Improve the sophistication of management preparedness in information security
- III Further strengthen the management of project risks
- IV Improving the effectiveness of governance for the entire NRI Group
- V Implement appropriate preparation for fulfilling our business continuity responsibilities
- VI Create comfortable working environments

Internal Audits Conducted by the Internal Audit Department

The Internal Audit Department (22 employees), which functions directly under the President & CEO, audits the Company to ensure the effectiveness of risk management and compliance systems and to maintain the efficiency of the execution of the Members of the Board.

The results of such audits are reported to the President & CEO and other directors, and when corrections or improvements are required, the Risk Management Supervisory Department, the representative departments, and the business divisions, collaborate to introduce improvements. In addition, the Internal Audit Department works to cooperate with the accounting auditor through regular exchange of opinions regarding plans for conducting internal audits and their results.

The Strengthening Global Governance

As a system for promoting its global strategies, NRI has established regional headquarters or holding companies in North America, Asia, and Australia. We are strengthening our governance system mainly for acquired subsidiaries. At Headquarters, NRI supports the formulation and execution of global strategies centered on its Global Headquarters established in April 2019. Through this initiative, we are working to strengthen governance at all overseas subsidiaries, including acquired subsidiaries.

Business Management through Local Holding Companies, etc.

	Local holding company, etc.	Territory regions
Nomura Research Institute	▶ NRI Australia (Sydney)	▶ Australia
	▶ NRI Holdings America (New York)	▶ United States
	▶ NRI Asia Pacific (Singapore)	▶ Asia
	▶ NRI Beijing (Beijing)	▶ Mainland China
		▶ Japan and Europe

Corporate Ethics and Compliance System

To ensure effective ethics and compliance systems, NRI has appointed the Chief Ethics Officer and Chief Compliance Officer and established the Compliance Committee. Moreover, we have established NRI Group's Code of Business Principles expressing the code of business principles and NRI Group Employees' Code of Business Conduct indicating our employees' code of business conduct.

 **NRI Group's Code of Business Principles**
https://www.nri.com/en/company/company_code

 **NRI Group Employees' Code of Business Conduct**
https://www.nri.com/en/company/business_code

The Fundamental Rules are composed of 12 items prepared and monitored to confirm that these principles and policies are complied with and that the company's management is reliably going in the right direction.

Regular training to raise the awareness of executives and employees toward compliance is conducted, as well as training on the legal knowledge, etc., required for individual operations. Through this training, efforts are made to thoroughly instill awareness on matters such as prohibitions on bribes and facilitation payments to public officials and the importance of compliance with antitrust laws.

 **NRI Group Policy on Human Rights / NRI Group AI Ethics Guidelines / NRI Group Anti-Bribery Policy / NRI Group Competition Law Compliance Policy / NRI Group Global Tax Policy**
<https://www.nri.com/en/sustainability/social/policies>

NRI has prescribed Whistleblower Protection Regulations based on the Whistleblower Protection Act and established internal and external hotlines as contact point that Japanese Group employees can use to consult with regarding compliance-related issues.

Compliance Information Communication Process

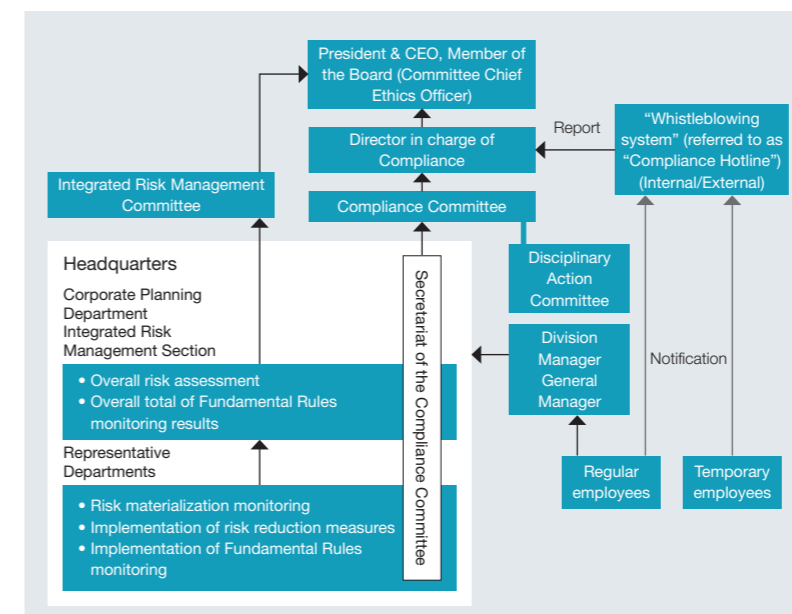

Raising and Instilling the Awareness of Executives and Employees through the Rule Book

We have created a Rule Book (Fundamental Rules for Executive Officers and General Staff) as a pamphlet that explains the action guidelines, etc., of the Company to ensure that executives and employees comply with laws, regulations, etc., with a high sense of ethics. By raising and instilling awareness of compliance using this, we work to put in place the foundations for our compliance structure.



Governance

NRI Executives

Newly appointed Independent Outside Non-executive Executive

Members of the Board



Shingo Konomoto Executive
 Date of birth: February 11, 1960
Chairman and President & CEO, Representative Director, Member of the Board (190,837 shares)

Apr. 1985 Joined the Company
 Apr. 2004 Senior Managing Director
 Division Manager of Consulting Division III
 Apr. 2010 Senior Corporate Managing Director
 Division Manager of Consulting Division
 Apr. 2015 Senior Executive Managing Director
 Head of Business, Head of Consulting
 Jun. 2015 Representative Director, Member of the Board, Senior Executive Managing Director
 Head of Business, Head of Consulting
 Apr. 2016 President & CEO, Representative Director, Member of the Board
 Jun. 2019 Chairman and President & CEO, Representative Director, Member of the Board (present)



Yasuo Fukami Non-executive
 Date of birth: August 12, 1960
Vice Chairman, Member of the Board (113,077 shares)

Apr. 1983 Joined the Company
 Apr. 2011 Senior Managing Director
 Deputy Division Manager of Distribution & Communication Solution Division
 Senior Corporate Managing Director
 Apr. 2016 Head of Distribution, Communication & Industrial Solutions
 Division Manager of Distribution & Communication Solution Division
 Apr. 2017 Senior Corporate Managing Director
 Head of Corporate Administration
 Apr. 2019 Senior Executive Managing Director
 Head of Corporate Headquarters
 Jun. 2019 Representative Director, Member of the Board, Senior Executive Managing Director
 Head of Corporate Headquarters
 Apr. 2021 Vice Chairman, Member of the Board (present)



Hironori Momose Non-executive
 Date of birth: September 15, 1961
Vice Chairman, Member of the Board (27,000 shares)

Apr. 1985 Joined The Nomura Securities Co., Ltd. (currently, Nomura Holdings, Inc.)
 Apr. 2008 Executive Managing Director of Nomura Securities Co., Ltd.
 Oct. 2008 Senior Managing Director of Nomura Securities Co., Ltd.
 Apr. 2013 Senior Corporate Managing Director of Nomura Securities Co., Ltd.
 Apr. 2016 Executive Vice President of Nomura Securities Co., Ltd.
 Apr. 2019 Adviser of Nomura Securities Co., Ltd.
 Jun. 2019 Vice Chairman, Member of the Board of the Company (present)



Hidenori Anzai Newly appointed Executive
 Date of birth: November 9, 1964
Senior Executive Managing Director, Representative Director, Member of the Board, Head of Corporate Headquarters (80,094 shares)

Apr. 1989 Joined the Company
 Apr. 2014 Senior Managing Director
 Deputy Division Manager of Distribution & Communication Solution Division
 Apr. 2017 Senior Managing Director
 Division Manager of IT Platform Services Division
 Deputy Division Manager of Systems Development Innovation Division
 Apr. 2019 Senior Corporate Managing Director
 Head of Corporate Administration
 Apr. 2021 Senior Executive Managing Director
 Head of Corporate Headquarters
 Jun. 2021 Representative Director, Member of the Board, Senior Executive Managing Director, Head of Corporate Headquarters (present)



Ken Ebato Newly appointed Executive
 Date of birth: October 28, 1963
Senior Executive Managing Director, Member of the Board, Head of Financial IT Solutions, Division Manager of Capital Markets & Wealth Management Solutions Division (118,195 shares)

Apr. 1987 Joined the Company
 Apr. 2015 Senior Managing Director
 Deputy Division Manager of Capital Markets & Wealth Management Solutions Division
 Apr. 2018 Senior Managing Director
 Division Manager of Capital Markets & Wealth Management Solutions Division
 Apr. 2019 Senior Corporate Managing Director
 Division Manager of Capital Markets & Wealth Management Solutions Division
 Apr. 2021 Senior Executive Managing Director
 Head of Financial IT Solutions
 Division Manager of Capital Markets & Wealth Management Solutions Division
 Jun. 2021 Member of the Board, Senior Executive Managing Director
 Head of Financial IT Solutions
 Division Manager of Capital Markets & Wealth Management Solutions Division (present)



Hiroshi Funakura Non-executive
 Date of birth: July 10, 1963
Member of the Board (84,704 shares)

Apr. 1986 Joined the Company
 Apr. 2008 Senior Managing Director
 Deputy Division Manager of Securities Systems Division
 Apr. 2014 Senior Corporate Managing Director
 Division Manager of Financial Solution Division
 Apr. 2018 Senior Executive Managing Director
 Head of Financial IT Solutions
 Apr. 2020 Adviser
 Jun. 2020 Member of the Board (present)



Hideaki Omiya Independent Outside Non-executive
 Date of birth: July 25, 1946
Member of the Board ^(Note 1) (3,351 shares)

Jun. 1969 Joined Mitsubishi Heavy Industries, Ltd.
 Jun. 2002 Member of the Board of Mitsubishi Heavy Industries, Ltd.
 Jun. 2005 Member of the Board (Representative Director), Executive Vice President of Mitsubishi Heavy Industries, Ltd.
 Apr. 2007 Member of the Board (Representative Director), Senior Executive Vice President of Mitsubishi Heavy Industries, Ltd.
 Apr. 2008 Member of the Board (Representative Director), President and CEO of Mitsubishi Heavy Industries, Ltd.
 Apr. 2013 Chairman of the Board (Representative Director) of Mitsubishi Heavy Industries, Ltd.
 Jun. 2014 Chairman of the Board of Mitsubishi Heavy Industries, Ltd.
 Apr. 2018 Member of the Board of the Company (present)
 Apr. 2019 Member of the Board, Senior Executive Advisor of Mitsubishi Heavy Industries, Ltd.
 Jun. 2019 Senior Executive Advisor of Mitsubishi Heavy Industries, Ltd. (present)

<Important concurrent positions>
 Senior Executive Advisor of Mitsubishi Heavy Industries, Ltd.
 Outside Director of SEIKO EPSON CORPORATION



Shinoi Sakata Independent Outside Non-executive
 Date of birth: March 31, 1957
Member of the Board ^(Note 1) (272 shares)

Apr. 1979 Joined Sumitomo Chemical Co., Ltd. (currently, SUMITOMO CHEMICAL COMPANY, LIMITED)
 Apr. 2011 Associate Officer of SUMITOMO CHEMICAL COMPANY, LIMITED
 Apr. 2013 Executive Officer of SUMITOMO CHEMICAL COMPANY, LIMITED
 Apr. 2016 Adviser of SUMITOMO CHEMICAL COMPANY, LIMITED (present)
 Director & Vice President of Sumika Technical Information Service, Inc.
 Jun. 2017 President of Sumika Technical Information Service, Inc.
 May 2018 Executive Director of Japan Chemical Industry Association (present)
 Jun. 2020 Member of the Board of the Company (present)

<Important concurrent positions>
 Adviser of SUMITOMO CHEMICAL COMPANY, LIMITED
 Executive Director of Japan Chemical Industry Association



Tetsuji Ohashi Newly appointed Independent Outside Non-executive
 Date of birth: March 23, 1954
Member of the Board ^(Note 1) (—)

Apr. 1977 Joined Komatsu Ltd.
 Jan. 2004 President and Chief Operating Officer (COO) of Komatsu America Corp.
 Apr. 2007 Executive Officer of Komatsu Ltd.
 Jun. 2009 Director and Senior Executive Officer of Komatsu Ltd.
 Apr. 2012 Director and Senior Executive Officer of Komatsu Ltd.
 Apr. 2013 President and Representative Director, and CEO of Komatsu Ltd.
 Apr. 2019 Chairperson of the Board and Representative Director of Komatsu Ltd. (present)
 Jun. 2021 Member of the Board of the Company (present)

<Important concurrent positions>
 Chairperson of the Board and Representative Director of Komatsu Ltd.
 Outside Director of Yamaha Motor Co., Ltd.

Audit & Supervisory Board Members



Takuhito Sakata
 Date of birth: November 20, 1961
Audit & Supervisory Board Member (full-time) (175,731 shares)

Apr. 1984 Joined the Company
 Apr. 2010 Senior Managing Director
 Deputy Division Manager of Distribution & Communication Systems Division
 Senior Managing Director
 Apr. 2011 Deputy Division Manager of Services & Industrial Solution Division I
 General Manager of Kansai Regional Headquarters
 General Manager of Chubu Regional Headquarters
 Apr. 2017 Senior Corporate Managing Director
 Division Manager of Data Center Service Division
 Deputy Division Manager of Cloud Computing Service Division
 Apr. 2020 Counselor of the Company
 Jun. 2020 Audit & Supervisory Board Member (present)



Kohei Sato Outside
 Date of birth: April 18, 1961
Audit & Supervisory Board Member (full-time) (1,573 shares)

Apr. 1984 Joined The Nomura Securities Co., Ltd. (currently, Nomura Holdings, Inc.)
 Apr. 2007 Executive Managing Director of Nomura Securities Co., Ltd.
 Oct. 2008 Senior Managing Director of Nomura Securities Co., Ltd.
 Apr. 2009 Director of Nomura Securities Co., Ltd.
 Apr. 2011 Senior Corporate Managing Director of Nomura Securities Co., Ltd.
 Apr. 2013 President and Chief Executive Officer, Representative Director of NOMURA BABCOCK & BROWN CO., LTD.
 Apr. 2018 Adviser of Nomura Securities Co., Ltd.
 Jun. 2018 Audit & Supervisory Board Member of the Company (present)



Motoya Nishimura
 Date of birth: July 23, 1962
Audit & Supervisory Board Member (full-time) (70,338 shares)

Apr. 1987 Joined the Company
 Apr. 2015 Managing Director, Deputy Division Manager of Systems Consulting Division
 Aug. 2015 Managing Director, Deputy Division Manager of the Systems Consulting Division, Deputy Division Manager of Insurance Solution Division
 Apr. 2018 Senior Managing Director, Deputy Division Manager of the Systems Consulting Division
 Apr. 2019 Counselor of the Company
 Jun. 2019 Audit & Supervisory Board Member of the Company (present)



Kiyotaka Yamazaki Independent Outside
 Date of birth: April 4, 1953
Audit & Supervisory Board Member ^(Note 1) (10,466 shares)

Oct. 1979 Joined M. Serizawa & CO. (CPA Office)
 Aug. 1983 Registered as a certified public accountant
 Jul. 2005 Partner of M. Serizawa & CO. (currently, GYOSEI & CO.)
 Oct. 2006 Managing Partner of GYOSEI & CO.
 Sep. 2007 Vice Executive Director, Partner of GYOSEI & CO.
 General Manager of Head Office Tokyo of GYOSEI & CO.
 Jul. 2010 Managing Partner (CEO) of GYOSEI & CO.
 Jun. 2014 Audit & Supervisory Board Member of the Company (present)
 Jul. 2014 Managing Partner of GYOSEI & CO.
 Oct. 2017 Partner of GYOSEI & CO.
 Oct. 2018 Adviser of GYOSEI & CO. (present)



Kenkichi Kosakai Newly appointed Independent Outside
 Date of birth: August 9, 1953
Audit & Supervisory Board Member ^(Note 1) (1,000 shares)

Apr. 1976 Joined Mitsubishi Chemical Industries Limited (currently, Mitsubishi Chemical Corporation)
 Jun. 2010 Director of the Board, Managing Executive Officer of Mitsubishi Tanabe Pharma Corporation
 Apr. 2014 Managing Executive Officer of Mitsubishi Chemical Holdings Corporation
 Apr. 2015 Senior Managing Executive Officer of Mitsubishi Chemical Holdings Corporation
 Jun. 2015 Representative Corporate Executive Officer, Senior Managing Corporate Executive Officer, Chief Financial Officer of Mitsubishi Chemical Holdings Corporation
 Apr. 2017 Representative Corporate Executive Officer, Deputy CEO, Chief Financial Officer of Mitsubishi Chemical Holdings Corporation
 Jun. 2017 Director of the Board, Representative Corporate Executive Officer, Deputy CEO, Chief Financial Officer of Mitsubishi Chemical Holdings Corporation
 Jun. 2019 Adviser of Mitsubishi Chemical Holdings Corporation
 Jun. 2021 Audit & Supervisory Board Member of the Company (present)

Note:
 1. Hideaki Omiya, Shinoi Sakata, and Tetsuji Ohashi are Outside Directors. Kiyotaka Yamazaki and Kenkichi Kosakai are Outside Audit & Supervisory Board Members. NRI specifies those members as Independent Directors pursuant to the regulations of the Tokyo Stock Exchange and has notified them to the said stock exchange.
 2. Members of the Board were selected at the Ordinary General Meeting of Shareholders held on June 18, 2021.
 3. For the Audit & Supervisory Board Members, Kohei Sato and Kiyotaka Yamazaki were selected at the Ordinary General Meeting of Shareholders held on June 22, 2018, Motoya Nishimura was selected at the Ordinary General Meeting of Shareholders held on June 20, 2019, Takuhito Sakata was selected at the Ordinary General Meeting of Shareholders held on June 18, 2020, and Kenkichi Kosakai was selected at the Ordinary General Meeting of Shareholders held on June 18, 2021.
 4. Figures in parentheses indicate number of the company's shares held. These list the number of shares held as of April 30, 2021, including holdings in the executive share ownership plan.

Managing Directors and Fellows

NRI makes a distinction between the Board of Directors' decision-making on management strategy and business execution function, and the authority and responsibilities for business execution are largely delegated to Senior Managing Directors, etc. There are 48 Senior Managing Directors, etc. (excluding three people who serve concurrently as a Member of the Board).

Senior Executive Managing Directors

Hajime Ueda Tomoshiro Takemoto
 Shigeki Hayashi Hirofumi Tatematsu
 Hiroshi Masutani Shuji Tateno

Senior Corporate Managing Directors

Fumihiko Sagano Tohru Yasumaru
 Yoichi Inada Tomohiko Noguchi
 Minoru Yokote Susumu Nishimoto
 Namiki Kubo Yoshihiko Sunaga
 Yuichi Higo

Senior Managing Directors

Katsutoshi Murakami Takeshi Hihara
 Hisao Nakajima Masaaki Yamazaki
 Yasushi Kobara Koji Shimizu
 Shoichi Ohno Hiroshi Koike
 Akira Matsumoto Ichiro Morisawa
 Tetsuro Watanabe Kazuya Kobayashi
 Shigekazu Ohmoto Noriyasu Kogure
 Hiroyuki Kawanami Kaga Yanagisawa
 Sonoko Kitagawa Kotaro Gunji
 Jun Odashima Hideki Saito
 Yasuki Nakamaru Katsuya Mori

Managing Directors

Takefumi Ikeya Toshifumi Hara
 Noriyuki Takeda Akihiro Kamei
 Masashi Shimizu Hiroyuki Nakayama
 Noriyuki Kobayashi Takao Yamaguchi

Research Directors

Yasuki Okai Fumihiko Kamio
 Kotaro Kuwazu

Fellow

Minoru Aoshima

NRI's Four Business Segments

NRI's business consists of mainly the four following business segments.

- Consulting: Consulting services
- Financial IT Solutions: IT solutions for the securities, insurance, banking, asset management, and other financial sectors
- Industrial IT Solutions: IT solutions for industrial clients in distribution, manufacturing, and service sectors
- IT Platform Services: Construction of IT platforms and networks that support NRI's IT solutions business and data center operations, in addition to system management solutions and security services for external clients

Revenue by segments for FY March 2020
(year-on-year changes)

Revenue including inter-segment revenue
(billions of yen)

Operating profit/
Operating margin
(billions of yen / %)

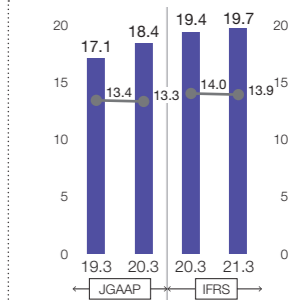
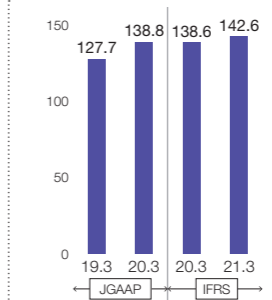
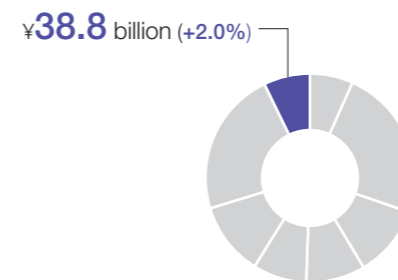
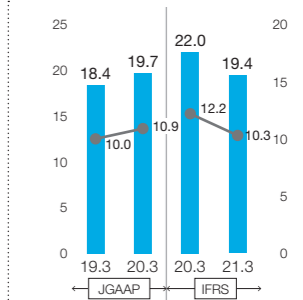
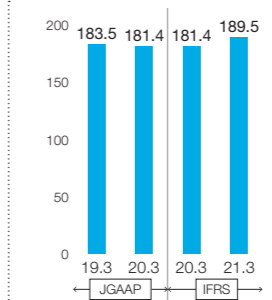
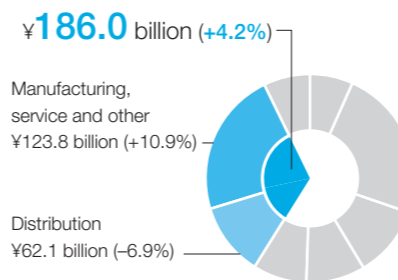
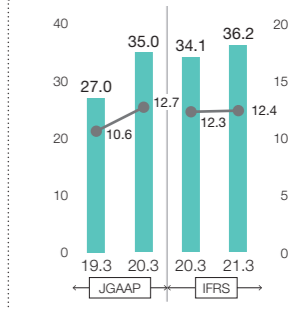
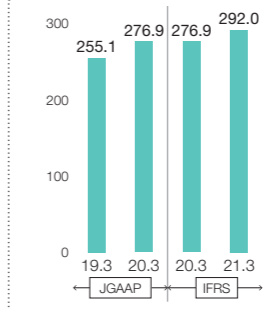
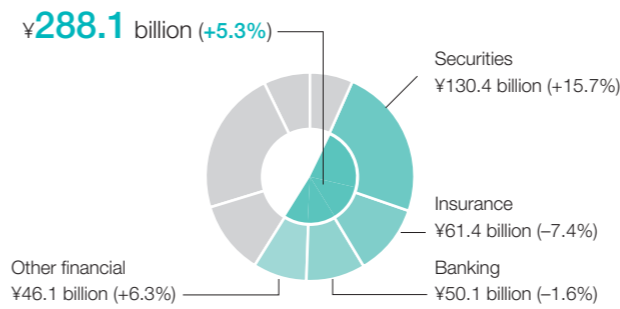
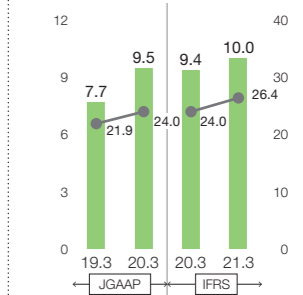
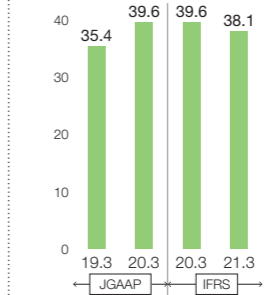
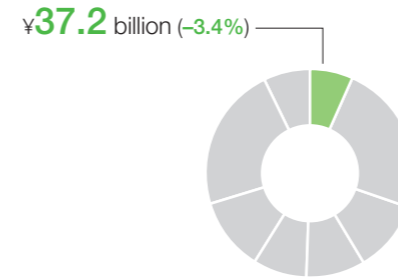

Clients

Consulting ➔ P. 94-95

This segment provides management consulting, operational consulting, and system consulting for enterprises and government agencies. This segment is also engaged in research, future projections, and recommendations related to society, economics, business, technology, etc.

Financial IT Solutions ➔ P. 96-97

This segment provides system consulting, system development, and system management solutions, shared online services, and BPO services for financial institutions mainly in the securities, insurance, banking, asset management, and other financial sectors.

Major affiliated companies

NRI Process Innovation, DSB, DSB Information System, Nippon Securities Technology, Cutter Associates

Industrial IT Solutions ➔ P. 98-99

This segment provides system consulting, system development, and system management solutions mainly for the distribution, manufacturing, service, and public sectors.

Major affiliated companies

NRI Netcom, NRI System Techno, NRI digital, Brierley+Partners, ASG Group, SMS Management & Technology Limited

IT Platform Services ➔ P. 100-101

This segment provides data center operations and construction of IT platforms and networks that are provided to the Financial IT and Industrial IT solutions segments. This segment also provides IT platform solutions and information security services to external clients. Furthermore, NRI conducts research related to advanced information technology, etc.

Major affiliated companies

NRI SecureTechnologies, NRI Data i Tech, NRI digital

Note: 1. Amounts have been rounded down to the nearest unit specified. However, percentages have been rounded off to the nearest digit specified.
2. There was a partial revision to segment categorization for FY March 2020. Figures for FY March 2019 reflect this change in categorization. Also, year-on-year comparisons use previous year figures that reflect this change in categorization.

Consulting Segment

The Consulting segment provides consulting services for policy planning for government agencies and strategy planning, business operation reforms, and all phases of IT management for companies.

We also have a strong track record in overseas markets including the Asia-Pacific, Europe, and the United States, where we have been tapped for numerous consulting projects by Japanese companies as well as local companies and governments.

Service Examples

- Support in medium- to long-term business planning, strategy planning, and overseas business strategy planning for companies
- Support in DX business development for companies
- Support in business process reform for the manufacturing industry, service industry, financial industry, etc.
- Support in IT governance standardized on a group or global basis
- Support in policy planning and execution support for government agencies



Segment Strengths

- One of Asia's largest consulting firms that has over 1,000 consultants in Japan and overseas
- Broad lineup of experts that cover an extensive range of industries and themes
- Consultants that understand strategy, operations, and IT
- Data analytics expertise developed through many years of experience in statistical analysis, marketing research, etc.



Recurring Shift Business model transformation in the manufacturing industry



Digital Capability Organizational abilities leading to successful DX

Domestic and International Business Environment (Client Trends)

Solving social issues through DX

- Consideration of incorporating decarbonization and other social issues into management strategy progresses

Acceleration in corporate reform by DX

- Expansion of business transformation themes by DX, further enhancement of transformation needs
- Increased needs for consulting to control projects
- Legacy core system and lack of IT human resources continue to hinder DX (domestic)

Non-transparent business environment and heightened difficulty of management

- Responding to rapid environmental changes such as the spread of COVID-19, and increased sophistication of issues
- Increasing needs for execution support leading to the concrete result of enhanced competitiveness



NRI Strategies and Countermeasures

Domestic business

- Solving social issues through co-creation with various partners
 - Carbon neutrality, circular economy, food value chain
 - Enhance DX-related solutions and service menus
 - Expansion of business transformation consulting by DX
 - Strengthen DX execution support such as business consulting and comprehensive support for client IT departments
- Strengthen customer responsiveness through increased sophistication of account management
 - Accurate response to client needs through internal collaboration
 - Strengthen ongoing business relationships through large-scale projects and promotion of cross-selling

Overseas business

- Strengthen proposal ability through global practice activities
- Search for DX-related intellectual property (IP) in developed countries such as Europe and United States

Activity results

Proposing rapid support for “substantially unemployed” non-regular employees and part-timers that have sharply increased during the COVID-19 pandemic

An investigation revealed that the actual circumstances of employment of non-regular employees and part-timers have been impacted by COVID-19 more severely than statistics show. Nationwide, 29.0% of all female non-regular employees/part-timers indicated that their shifts had decreased due to COVID-19, and 45.2% of those individuals (13.1% of the total) indicated that their shifts had decreased by 50% or more.

Non-regular employees and part-timers whose shifts have "decreased by 50% or more" and "are not receiving a temporary business closure allowance" have been defined as "substantially unemployed individuals." It is estimated that 1,031,000 women and 434,000 men were in that category as of February 2021. Substantially unemployed individuals are generally not included in the statistics for the unemployed or for individuals on leave due to a temporary business closure.

Further, the survey found that many substantially unemployed individuals are not aware that they can receive a temporary business closure allowance and that many wanted to look for a new job. In light of the findings of the investigation, we suggested that there was an urgent need to encourage the recognition and use of economic support

for non-regular employees and part-timers and to expand supportive measures that encourage labor mobility (changing jobs), in order to prevent a worsening of economic and societal circumstances as well.



Shinichiro Umeya
Center for Strategic Management & Innovation



Kana Takeda
Center for Strategic Management & Innovation

Changes in shifts compared with pre-COVID-19

(Female non-regular employees/part-timers)



Source: NRI "Investigation of the Actual Circumstances of Non-regular Employees/Part-timers" (Feb. 2021)

Investigation of streamlining the overall recycling process with the aim of reducing carbon dioxide emissions from energy sources

In order to achieve a circular economy, it is necessary to implement initiatives based on the overall optimal thinking that will further increase the efficiency of resource recycling, and the creation of a mechanism to share each type of information is an extremely important issue for encouragement of collaboration throughout the industry and between individual industries. In such circumstances, artificial intelligence (AI), the Internet of Things (IoT), blockchains, and other digital technologies that have been rapidly advancing are expected to contribute significantly to efficient and effective information sharing and collaboration between entities.

In a project consigned by the Ministry of the Environment, NRI conducted an investigation and made recommendations regarding the possibility of demonstration projects in the product and materials area, which has significant potential, with the aim of establishing information platform business related to resource recycling throughout society. Specifically, we considered a unified information collaboration system aimed at efficient collection of used solar panels

and appropriate reuse and recycling, as well as a system for management of waste from factories, which is unified through a shared categorization axis, and other matters.

Image of cooperation between arteries and veins through DX

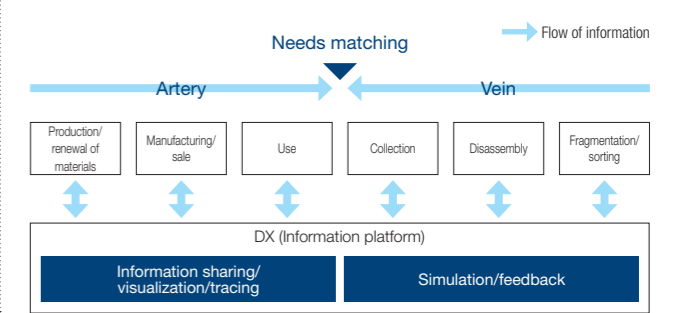

Discussion of the current circumstances in digital government in Denmark and Japan, and the direction in the future

NRI CODO* hosted the Denmark Digital Government Webinar: The Current State and Future of Denmark's Globally Top-rated Digital Government.

Taking the top spot in the United Nations World e-Government Rankings for two years in a row, Denmark has shown a high level of international competitiveness through innovation and has seen the birth of many unicorn companies. The reason for Denmark's success is thought to be the Scandinavian model that is based on enhancing the infrastructure of information communication technology (ICT), which has developed conspicuously in recent years, in addition to societal mechanisms displayed in the welfare state that has garnered attention for many years.

NRI gave lectures on comparisons between the current state of Denmark's digital government and that of Japan, as well as the impact and orientation of response in the creation of Japan's digital government. Specifically, the status of consideration of Japan's digital government (My Number verification, e-Post Office Box, open data, government information system, etc.), characteristics

and issues of Japan's initiatives as compared with those of Denmark, examples of local governments that are actively working to promote digital government, etc.

* A co-creation space for development of new business and exploration of new value through collaboration with countries/regions and clients



A view of the webinar (Left)
Karen Ejersbo Iversen
Ministry of Finance, Denmark
Agency for Digitalisation, Denmark (Right)
Fumihiko Kamio
Research Director

Financial IT Solutions Segment

This segment provides system consulting, system development, and system management solutions, shared online services, and BPO services for financial institutions mainly in the securities, insurance, banking, asset management, and other financial sectors.

Moreover, NRI is utilizing the expertise of the financial industry cultivated over many years and the latest digital technology to support DX of financial institutions in operations and services.

Service Examples

- Core business systems and information systems of Nomura Securities Co., Ltd.
- ATM network systems and accounting systems of Seven Bank, Ltd.
- Shared online services that have become the de facto standard: THE STAR, STAR, T-STAR, and BESTWAY



Segment Strengths

- Strong client base based on business with top-class financial institutions in the industry and other clients over many years
- Shared online services that have the leading market share in the financial industry
- Utility services provided jointly with Group companies (IT solutions + BPO services)
- Close communication with financial authorities, industry organizations, etc. (supports for policy planning for the My Number system, NISA system, etc.)
- Think tank activities that discuss and communicate on financial

policy and financial intermediary function issues (Research Forum for Revitalization of Financial Intermediation in Domestic Economy, Japan-China Financial Roundtable)



Ranked 11th in the global ranking of financial IT service companies released by IDC Financial Insights

Domestic and International Business Environment (Client Trends)

Changes to the environment surrounding the financial industry

- Securities: Strong financial market
- Banking: Expansion of new forms of bank and entry of companies from other industries
- Insurance: Revitalization of development of small-amount short-term insurance through revision of the Insurance Business Act
- Asset management industry: Domestic market that is forecast to Grow. Revitalization of movement to newly establish management firms

Increased digitalization due to the COVID-19 pandemic

- Establishment of remote work (non-face-to-face, no-contact)
- Increased need for business model transformation through digitalization and entry of companies from other industries
- Spread of My Number and advancement of conversion to paperless
- Expansion of demand for BPO from the perspective of business continuity



NRI Strategies and Countermeasures

Expansion of industry-standard business platforms

- Expansion of cloud-native, inter-business-category services that exceed conventional financial industry framework
- Response to diverse services needs through provision of API
- Expansion of ITO x BPO services united with Group companies

Creation and expansion of digital financial services

- Promotion of new DX business that contributes to My Number and other digital government policy
- Expansion of financial business platforms for the front office in securities companies
- Response to new forms of bank and entry of companies from other industries
- Provision of the InsDirect/MP solution for mini insurance
- Expansion of front functions for asset management firms

Acceleration of global business expansion

- Stable operation and expansion of business of AUSIEX (Australia)
- Taking on the challenge of further growth through M&A

Activity results

Issuance of “digital asset bonds” and “digital bonds,” which are corporate bonds that utilize blockchain technology for the first time in Japan

In March 2020, NRI issued “digital asset bonds” and “digital bonds,” which are corporate bonds that utilize blockchain technology. It was the first time for a Japanese company to do so. At the time of the issuance, BOOSTRY Co., Ltd., which was founded as a joint venture in 2019 by Nomura Holdings, Inc. and NRI, provided the “ibet” blockchain infrastructure. In the case of “digital asset bonds,” NRI recruits investors through a smartphone app that connects to ibet, and grants digital assets (points that can be used at a cafe in this case) in place of interest.

BOOSTRY Co., Ltd., developed the shared platform ibet, which enables the creation, transfer, and usage of bonds and stocks, as well as various rights such as ownership rights, memberships, and digital assets. As a result, it is possible to handle products that previously had a low level of liquidity. Therefore, we expect expansion of the capital market.

By providing new platforms for society to support the activities of business corporations, etc., NRI will achieve new forms of finance.



Provision of the InsDirect/MP online complete business package for mini insurance

Implementation of a small-amount short-term insurance system through revision of the Insurance Business Act has led to the development of small-amount short-term insurance (mini insurance) that makes it possible to provide just the necessary amount of coverage at the necessary timing for limited risks that had not been covered by conventional insurance or mutual aid programs, such as medical insurance coverage that could be acquired even if the individual had a chronic condition, and electronic appliance malfunction insurance/insurance coverage extension services. There has also been an increase in the number of companies outside the insurance industry, such as retailers and platformers, participating as providers of mini insurance.

In light of these increasing needs, NRI released the mini insurance business system package InsDirect/MP in September 2020. In addition to streamlining implementation of the system, this package reduces confirmation work when investigating the impact of system renovation. Because of this, it is possible to propose and

modify product strategy and sales strategy dynamically while checking the needs of the insured person.

NRI is working to implement DX in insurance business to respond to new insurance needs of consumers and spread peace of mind in daily living in the future.



Taking transaction screening at securities companies to a higher level through the utilization of artificial intelligence (AI)

Securities companies are required to screen transactions, in which the transactions of investors are monitored, and customers are alerted if evidence of unfair trading is discovered. In recent years, a type of unfair trading called “market manipulation” has become more complex and sophisticated, and therefore more difficult to discover with only the transaction data possessed by a single securities company due to the use of multiple securities companies.

The NRI Group's DSB Co., Ltd., has begun conducting transaction screenings using AIFIX, an AI-based unfair trading detection algorithm developed by DSB Information System Co., Ltd. AIFIX was developed through joint research in an industry-academia collaboration with the University of Tokyo's Matsuo Laboratory, led by Professor Yutaka Matsuo. By adding screening and detection logic to the current transaction screening process, transaction screening work was significantly streamlined, and detection was conducted at a high level of precision even in the case of alert items.

The NRI Group streamlines the transaction screening work of securities companies, supports deep transaction screening, and contributes to the healthy development of the financial instruments market.



Industrial IT Solutions Segment

Operations in this segment comprise integrated consulting, system development, and system management solutions for the distribution retail/wholesale, manufacturing, communications, service, and public sectors.

We are strengthening our relationship as a long-term business partner with industry-leading corporations. Through these relationships, we seek to create new value.

Service Examples

- Order and supply system and POS information system for major convenience stores
- Customer service support tool for shops of a major communication carrier
- Total beauty website service of a major cosmetics manufacturer
- Dynamic package website for a major airline



Segment Strengths

- Technical capabilities and experience in building mission-critical systems accumulated over many years
- Compelling proposals and record of implementation fusing package solutions and cloud services
- Business analysts and data scientists cooperate to analyze customer data and propose solutions to business issues such as demand forecasting, logistics forecasting, price optimization, and customer segmentation
- Cultivate experts in each field to support expanded business and increased competitiveness at clients, and accumulate industry-specific research results through advanced technology



In August 2019, opened the NRI Shenzhen Innovation Scene from venue of the real estate DX seminar Center as an R&D base of DX

Domestic and International Business Environment (Client Trends)

Expansion of e-commerce due to the COVID-19

- Rapid increase for home delivery needs
- Impersonalization of sales and service

Evolution of technologies such as mobile, cloud, and AI

- Utilization of technology to significantly change the business model and players in the industry

Spread of network-type products in the manufacturing industry

- Network services that significantly affect product value

Renewal of core systems

- Expanded utilization of package solutions and cloud services
- Construction of a secure and stable system infrastructure



NRI Strategies and Countermeasures

B2C e-commerce and digital marketing

- Support for the continued growth of clients' e-commerce businesses
- Utilization of advanced R&D results such as customer fitting, hybrid recommendations, and loyalty point programs

B2B e-commerce

- Construction of a strong e-commerce platform that supports transactions among corporations in the e-marketplace
- Algorithm for high-speed search of an enormous number of products

Supply chain and logistics management

- Provision of solutions for solving business issues, from overall resource plans in the supply chain to delivery route optimization

Enterprise AI

- Replace work that has been performed based on experience and rules with automated operations utilizing artificial intelligence (AI) and machine learning (ML)

Package integration

- When introducing ERP, provision of total solutions that both differentiate value-added operations and standardize indirect operations

Mission-critical systems

- High availability and rapid service expansion 24 hours a day, 365 days a year

Activity results

Achievement of improved safety, productivity, and environmental friendliness in the construction industry through DX

In July 2021, Komatsu, NTT Docomo Inc., Sony Semiconductor Solutions Corporation, and NRI jointly launched the new company EARTHRAIN Ltd. (EB) with the aim of implementing DX in the construction industry and achieving dramatic improvements in safety, productivity, and environmental-friendliness.

Social issues faced by the construction industry in Japan, such as aging of employees and a decreasing worker population, as well as the spread of COVID-19, have made it necessary to reform the work style at construction sites around the world. EB utilizes digital technology to take the smart construction ordinarily provided by Komatsu to a higher level, monitoring the entire process of production remotely, and controlling it at the optimal level, thereby safely improving productivity and creating a smart and clean workplace of the future. NRI supports DX in the construction industry through

development of solutions and providing services that utilize its insight in business model transformation and digitalization.



Holding of a real estate DX seminar under the theme of "Pathway to Smart Cities"

NRI and NRI Digital hosted the 4th Real Estate DX Seminar in March 2021. In recent years, although the enactment of the Super City Act and other developments related to smart cities have accelerated on one hand, there are also a variety of hurdles to the achievement of smart cities, and the gap between the ideal and reality has become clear. During the seminar, under the theme "Pathway to Smart Cities," five consultants and business designers provided suggestions from a variety of perspectives for achievement of smart cities, addressing smart city trends and the thinking behind implementation and establishment of systems, etc.

In the future as well, NRI will communicate information, provide solutions, and support DX in the creation of smart cities and other aspects of the real estate industry.



Communicating initiatives related to the physical Internet in Japan

Yamato Group Research Institute (Yamato Research) and NRI were in charge of planning and operating sessions of the 8th Annual International Physical Internet Conference (IPIC), an international conference related to the physical Internet that was held in June 2021, and communicated efforts related to the physical Internet in Japan.

The physical Internet is an innovative distribution system in which logistics companies share and mutually use information related to the physical space of trucks and other means of transportation, as well the supplementary physical space of warehouses. We will achieve a sustainable society by controlling fuel consumption of trucks, etc., and reducing the burden on the environment, while at the same time increasing the rate of operation of transportation and storage space. Yamato Research and NRI have collaborated to conduct research related to the physical Internet up to this point.

The two companies will collaborate in the future as well, and move forward with initiatives related to the physical Internet in Japan, and communicate it to the world.



IT Platform Services Segment

The segment provides services such as the management, multi-cloud services, and operation of data centers and IT platform/network development to the Financial and Industrial IT solutions segments. We also carry out research toward development of new businesses and new solutions and research in cutting-edge information technology.

Service Examples

- Operates three data centers in the Tokyo area and two in the Osaka area
- NRI SecureTechnologies, Ltd., provides one-stop information security services from sophisticated security operations and surveillance and consulting, to various types of software and services
- NRI digital, Ltd., supports digital business with “Con-Solution” and open innovation



Segment Strengths

- Data centers with facilities and operational management capabilities that conform to the highest standards
- Management operation centers in five locations in Japan and network hubs around the world
- Security business that supports companies' global development
- Specialty company (NRI digital, Ltd.) that supports digital business creation
- Information technology trend projections over many years (publication of the IT Road Map, etc.)
- Investigation and research on AI (artificial intelligence), deep learning, voice recognition, image recognition, character recognition, etc.
- Acquisition of various global certifications
<https://www.nri.com/jp/sustainability/evaluations#amc03>



The IT solutions infrastructure* NRI Cloud provided by NRI has acquired ISO/IEC 27001 and ISO/IEC 27017 certification from the Japan Quality Assurance Organization (JQA) (as of October 19, 2018).
* General name of NRI solutions for IT infrastructure to achieve stable operation of client systems
<https://www.nri.com/en/service/ips/managed>

Domestic and International Business Environment (Client Trends)

Multi-cloud services business

- Full-scale IT investment activities in clients' digital areas
- Establishment of “public cloud first” with clients
- Acceleration of business model and process transformation in anticipation of post-COVID-19

Digital workplace business

- Diversification of work locations due to the COVID-19 pandemic
- Emergence of no-contact services and other new needs
- Increased need for work-style reform

Security business

- Normalization and expansion of the scope of security threats
- Increased security needs to support zero-trust security and DX

DX production innovation

- Increased reform of client organizations through DX
- Shortage of DX personnel in client organizations



NRI Strategies and Countermeasures

Multi-cloud services business

- Provision of safe and secure IT infrastructure services
- Enhancement of the ability to take action in the DX area
- Streamlining through the use of cloud-related technology, etc.

Digital workplace business

- Creation of a high-quality office infrastructure and voice infrastructure
- Expansion of services that respond to new needs, such as no-contact interaction
- Provision of services to improve the convenience of the workplace

Security business

- Response to the migration to zero trust, cloud security for DX, and other areas with significant needs
- Provision of constant security diagnoses through utilization of the cloud

DX production innovation

- Higher level of DX support (enterprise agility, low-code development, etc.)
- Provision of AI solutions
- Technological trend surveys, search for new technology

Activity results

Promotion of measures against infection in the office through digital technology

In order to promote measures against the spread of infection of COVID-19 in offices, NRI utilized the cutting-edge technology of Amazon Web Services (AWS) to develop the NRI AI Camera, a safe and secure AI image analysis solution that considers the protection of personal information.

To avoid the three Cs in work areas, conference rooms, and other office areas, AI cameras automatically detect whether employees are wearing masks or coming into close proximity, etc., and give audio warnings. The image data acquired by the AI camera is discarded at the camera terminal through edge computing technology, and only the post-analysis data is sent to the cloud. Utilizing a variety of AWS services in the cloud enables high-level visualization and analysis. NRI uses digital technology to prevent infection of COVID-19, in order to contribute to the restart of

business activities “with COVID-19” and “after COVID-19,” which is a significant issue for companies.



The NRI AI Camera for Office detects that the person at the left side of the screen is not wearing a mask (indicated by the red frame) and gives an audio warning to wear a mask

Achievement of at-home call centers in a short period of time

NRI provides CC@Home, a platform that makes it possible to conduct call center work at home, without going in to the call center, even in the midst of the spread of COVID-19.

CC@Home not only provides consultation to achieve an at-home call center, and is not merely FAQ support or preparation of a cloud-type call center system that resolves technical issues related to at-home call center infrastructure, but it also utilizes digital technology to support mental health management, such as making daily measurement of stress, and identification of mental fatigue and stress to identify signs of mental health issues caused by working at home. CC@Home resolves a variety of issues related to at-home work, and enables implementation in short periods of a few months. NRI supports the sustained business of companies through digital technology.

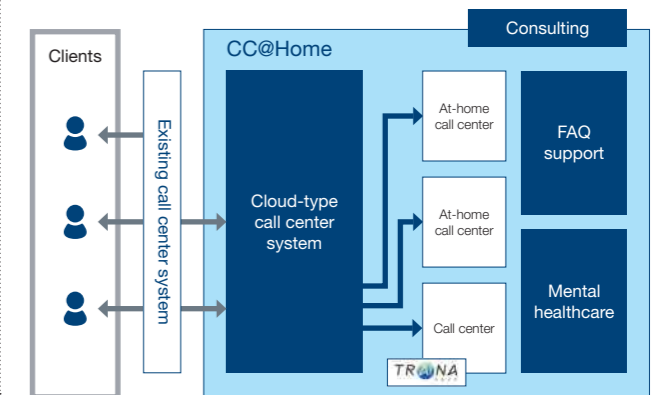

Creating an attractive community through XR technology and art

At Yokohama Triennale 2020, an international exhibition of contemporary art held in 2020, NRI took on the challenge of creating a new artistic experience using XR technology*.

In addition to enabling first-time visitors to Minatomirai to arrive at the venue without worry by having them scan a QR Code on a postcard, connect to an app, and display a map of Minatomirai, etc., it is possible to get background stories on the artists and their works displayed around town. In addition, by selecting “View in AR,” visitors could display a faithfully reproduced AR work on the postcard. The use of XR technology also made it possible to see things that would have been impossible in real life, such as works of art made of lead sinking to the bottom of the ocean.

XR is expected to become one answer as a medium for communicating messages with a spatial effect in 3D. NRI expects XR and other technology to change the patterns of behavior and awareness of companies and individuals and give birth to better circulation in the community.

* XR technology: A comprehensive term for augmented reality (AR), virtual reality (VR), and mixed reality (MR)



NRI Group Network (As of the end of March 2021)

Headquarters

Nomura Research Institute, Ltd.

Otemachi Financial City Grand Cube,
1-9-2, Otemachi, Chiyoda-ku,
Tokyo, 100-0004, Japan
Tel. +81(3)5533-2111

Domestic Bases

NRI Netcom, Ltd.
NRI SecureTechnologies, Ltd.
NRI Workplace Services, Ltd.
NRI Data i Tech, Ltd.
NRI Social Information System Services, Ltd.
NRI Process Innovation, Ltd.
NRI System Techno, Ltd.
UBsecure, Inc.
DSB Co., Ltd.
DSB Information System Co., Ltd.
NRI Mirai, Ltd.
Zhiming Software Japan, Ltd.
NRI Retail Next, Ltd.
Brierley+Partners Japan, Inc.
NRI digital, Ltd.
NDIAS, Ltd.
Financial Digital Solutions, Ltd.
Nippon Securities Technology Co., Ltd.

Overseas Bases

[U.S.]

Nomura Research Institute Holdings America, Inc.
Nomura Research Institute America, Inc.
Nomura Research Institute IT Solutions America, Inc.
Pacific Branch
NRI Secure Technologies, Ltd. North America Branch
Cutter Associates, LLC
Brierley+Partners, Inc.

[Europe/Russia]

Nomura Research Institute Europe Limited
Luxembourg Branch
Cutter Associates Europe, Ltd.
Brierley Europe Limited
Nomura Research Institute, Ltd. Moscow Branch

[Asia/Pacific]

Nomura Research Institute Australia Pty Ltd.
Perth Office
ASG Group Limited
Sydney Office
Canberra Office
Melbourne Office
Brisbane Office
Adelaide Office
Cutter Associates Australia Branch

Nomura Research Institute (Beijing), Ltd.
Shanghai Branch
Dalian Branch

Nomura Research Institute Shanghai Limited
Beijing Branch

Nomura Research Institute (Dalian), Ltd.

Zhiming Software Beijing, Ltd.
Chengdu Branch

Zhiming Software Dalian, Ltd.

Zhiming Software Jilin, Ltd.

Nomura Research Institute Taiwan Co., Ltd.

Nomura Research Institute Seoul Co., Ltd.

Nomura Research Institute Thailand

Nomura Research Institute Asia Pacific Private Limited

Nomura Research Institute Singapore Pte. Ltd.
Manila Branch

Nomura Research Institute Hong Kong Limited

PT. Nomura Research Institute Indonesia

Nomura Research Institute Consulting and Solutions India Private Limited

Nomura Research Institute Financial Technologies India Pvt. Ltd.

For more about NRI Group offices around the world:
<https://www.nri.com/en/company/map>

NRI Group Worldwide Offices

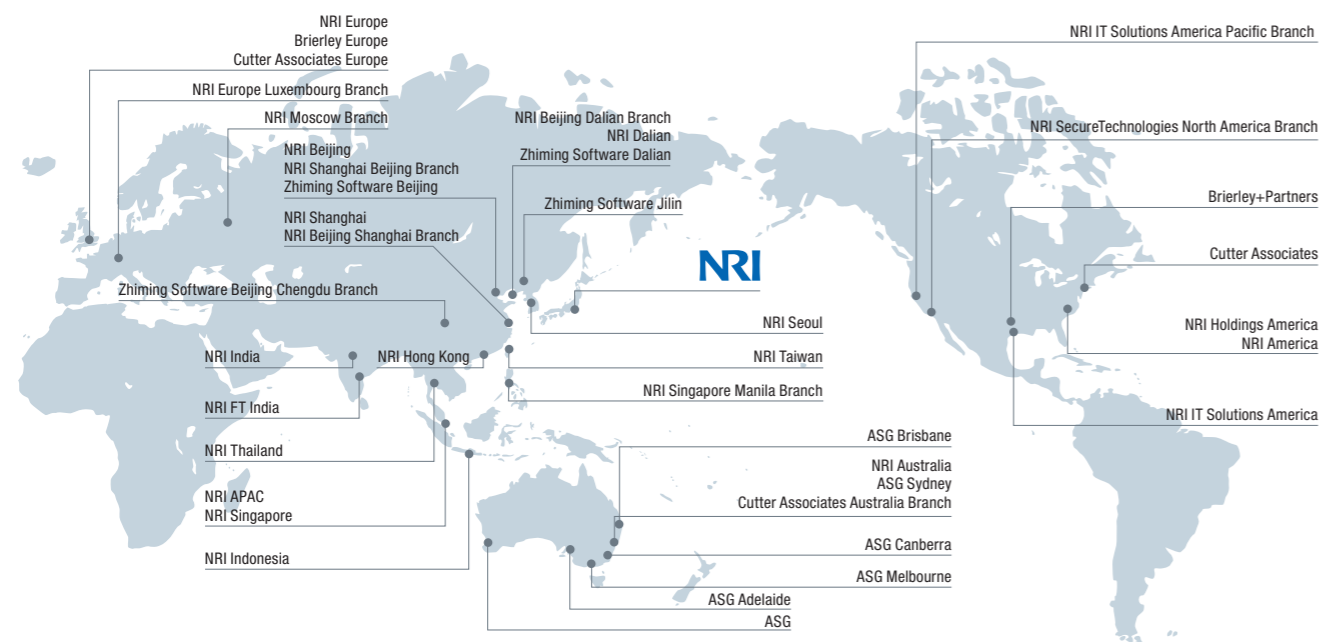

Corporate Data / Share Information (As of the end of March 2021)

Corporate data

Name	Nomura Research Institute, Ltd.
Headquarters address	Otemachi Financial City Grand Cube, 1-9-2 Otemachi, Chiyoda-ku, Tokyo 100-0004, Japan
Capital	¥21,175 million
Representative	Chairman and President & CEO, Representative Director Shingo Konomoto
Number of employees (Consolidated base)	13,430 persons

Share information

Listed stock exchange	Tokyo Stock Exchange 1st. Section
Code	4307
Fiscal year	From April 1 to March 31 of the following year
Ordinary General Meeting of Shareholders	June
A share unit	100 shares
Authorized shares	2,722,500,000 shares
Issued shares	610,000,000 shares
Number of shareholders	18,445 persons
Transfer agent (address for inquiries posts)	Mitsubishi UFJ Trust and Banking Corporation Shin-TOKYO Post Office Post office box No. 29 137-8081, JAPAN Mitsubishi UFJ Trust and Banking Corporation Corporate Agency Division Tel: 0120-232-711 (toll-free)
Shareholder fixed day for dividend payment	September 30, March 31

Component ratio of shareholders

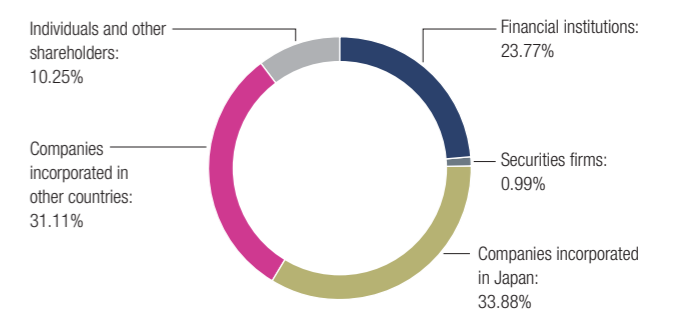

Major shareholders

Shareholders	Number of shares held (1,000 shares)	Percentage of shares held (%)
Nomura Holdings, Inc.	106,425	17.54
Nomura Facilities, Inc.	67,518	11.13
The Master Trust Bank of Japan, Ltd. (Trust Account)	34,590	5.7
NRI Group Employee Stock Ownership Group	28,739	4.74
Nippon Life Insurance Company (Standing Agent: The Master Trust Bank of Japan, Ltd.)	24,727	4.08
JP Morgan Chase Bank 385632 (Standing Agent: Mizuho Bank, Ltd., settlement division)	24,578	4.05
JAFCO Co., Ltd.	23,968	3.95
Japan Trustee Services Bank, Ltd. (Trust Account)	22,954	3.78
State Street Bank and Trust Company 505223 (Standing Agent: Mizuho Bank, Ltd., settlement division)	13,870	2.29
National Mutual Insurance Federation of Agricultural Cooperatives (Standing Agent: The Master Trust Bank of Japan, Ltd.)	13,434	2.21

Note: 1. NRI has 3,385 thousand shares of treasury stock as of March 31, 2021, which is not included in the major shareholders list above.
2. Figures for number of shares held are rounded down to the nearest thousand and figures for percentage of shares held are calculated excluding treasury stock.
3. Nomura Facilities Inc. merged with Nomura Land & Building Co., Ltd., on April 1, 2021, and changed its name to Nomura Properties, Inc.

Total Shareholder Return (TSR) Over the Past Five Years

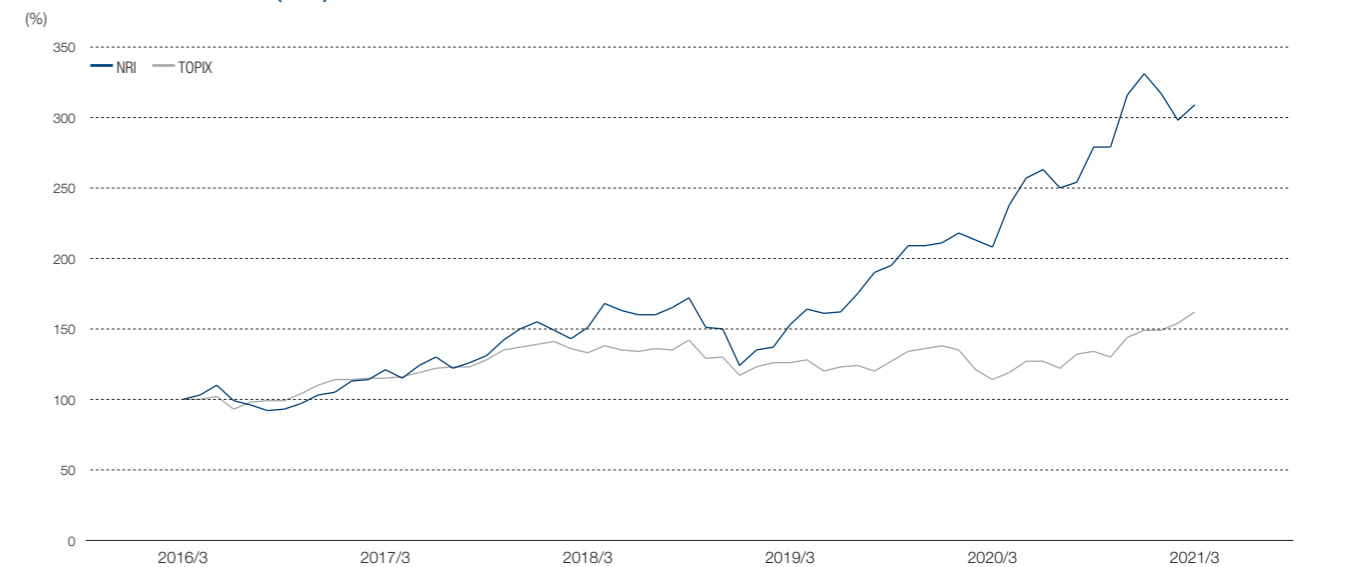

Holding Period	1 year	2 years	3 years	4 years	5 years
NRI	121.2%	151.1%	153.4%	209.4%	311.6%
TOPIX	114.7%	132.9%	126.2%	114.2%	162.3%

Note: Total shareholder return (TSR) is a ratio calculated by dividing revenues earned through stock investment (dividends and capital gains) by the amount of investment (stock price). The graph and table shown above display the TSR when investment was made on March 31, 2015. Based 100% on the closing price on March 31, 2015. Source: Compiled by NRI.